

Color And Trace - Alphabet Worksheet

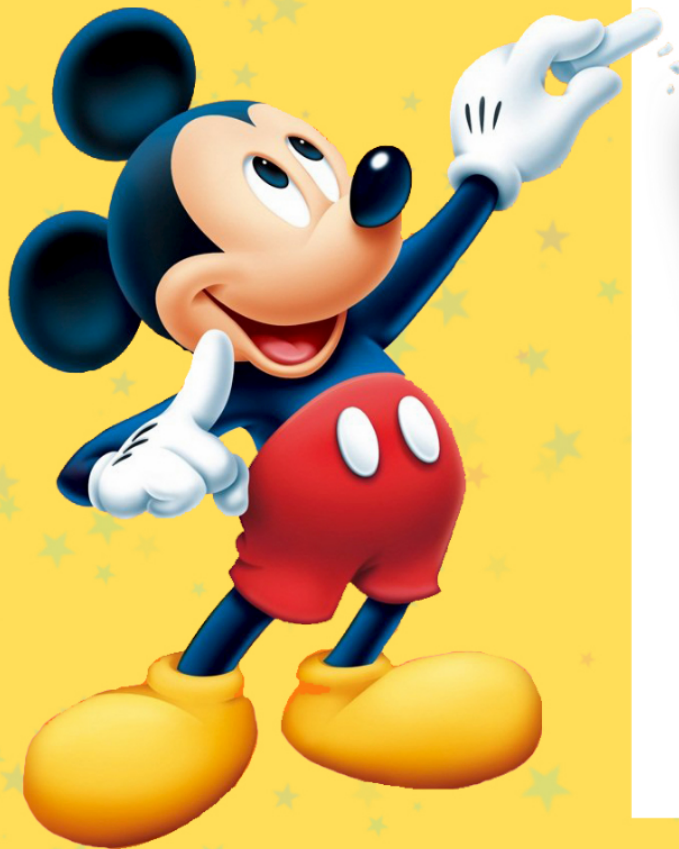

Name: _____

Date: _____

Color the drawing and trace the word

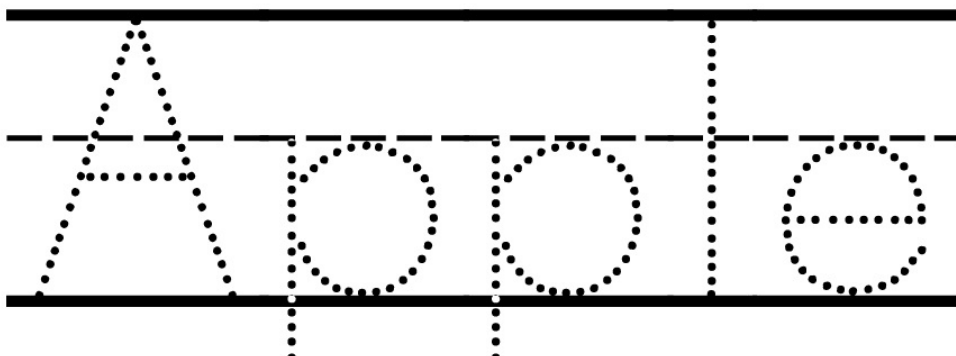
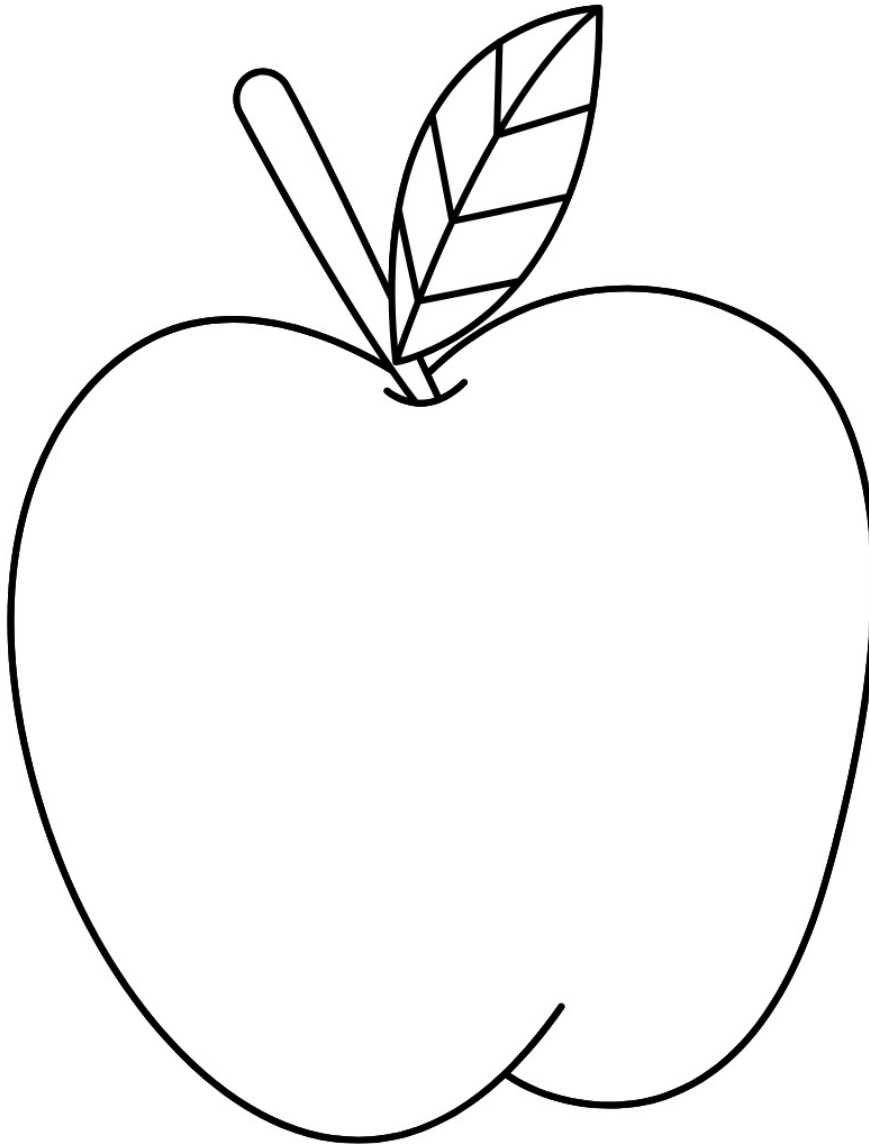

Name: _____

Date: _____

Color the drawing and trace the word

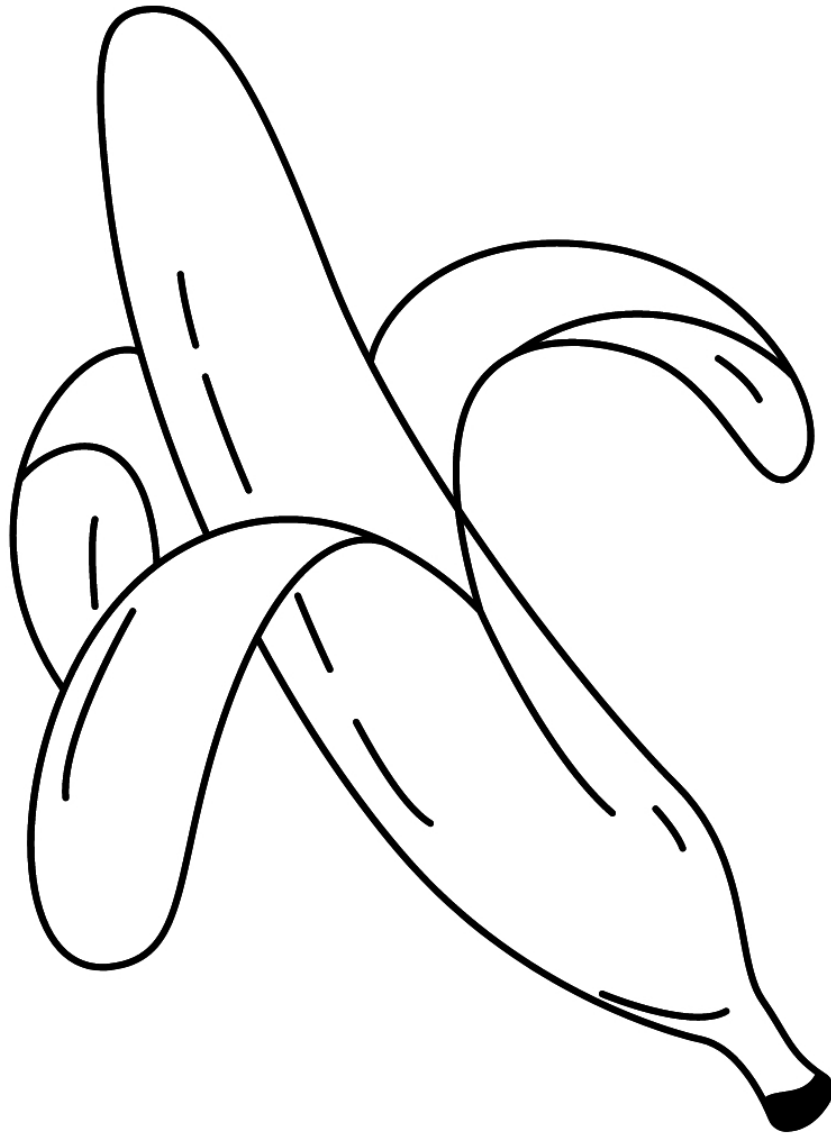

Name: _____

Date: _____

Color the drawing and trace the word

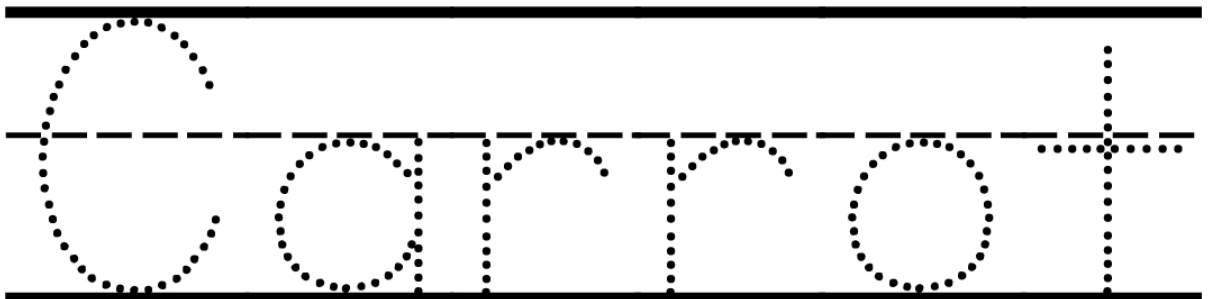
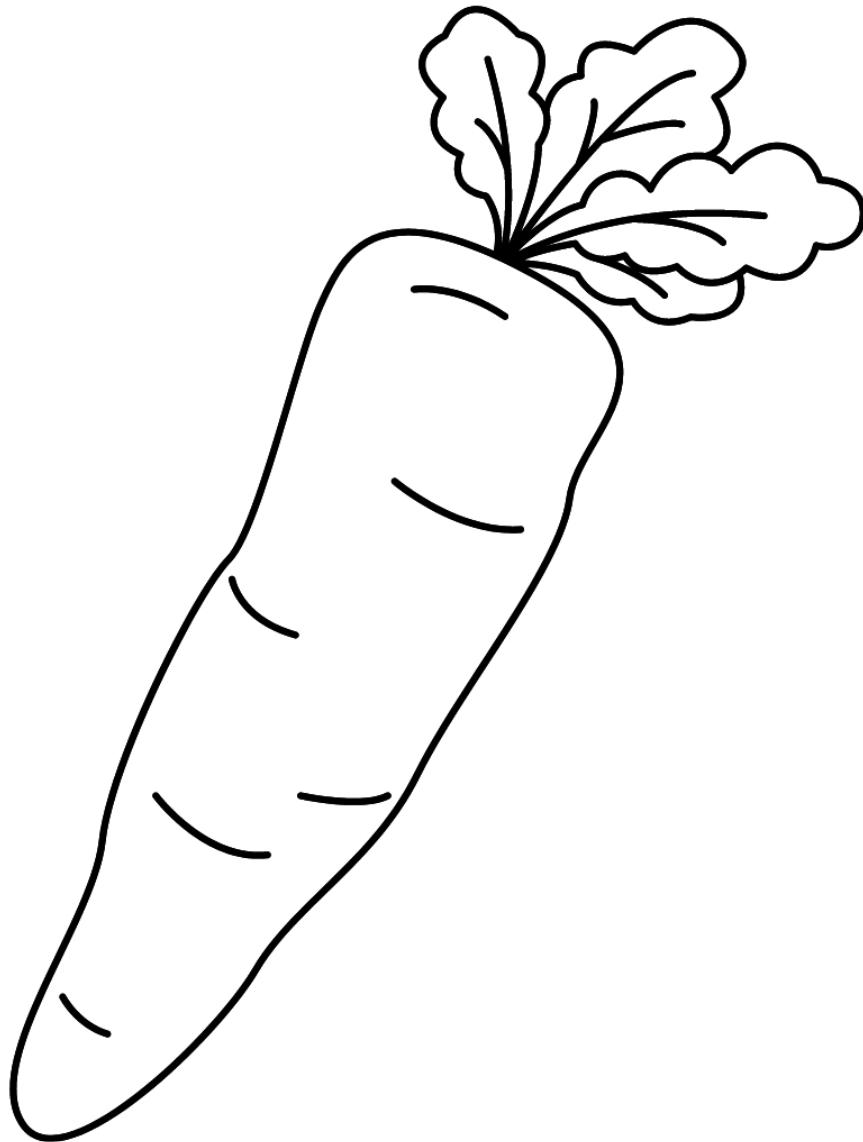

Name: _____

Date: _____

Color the drawing and trace the word

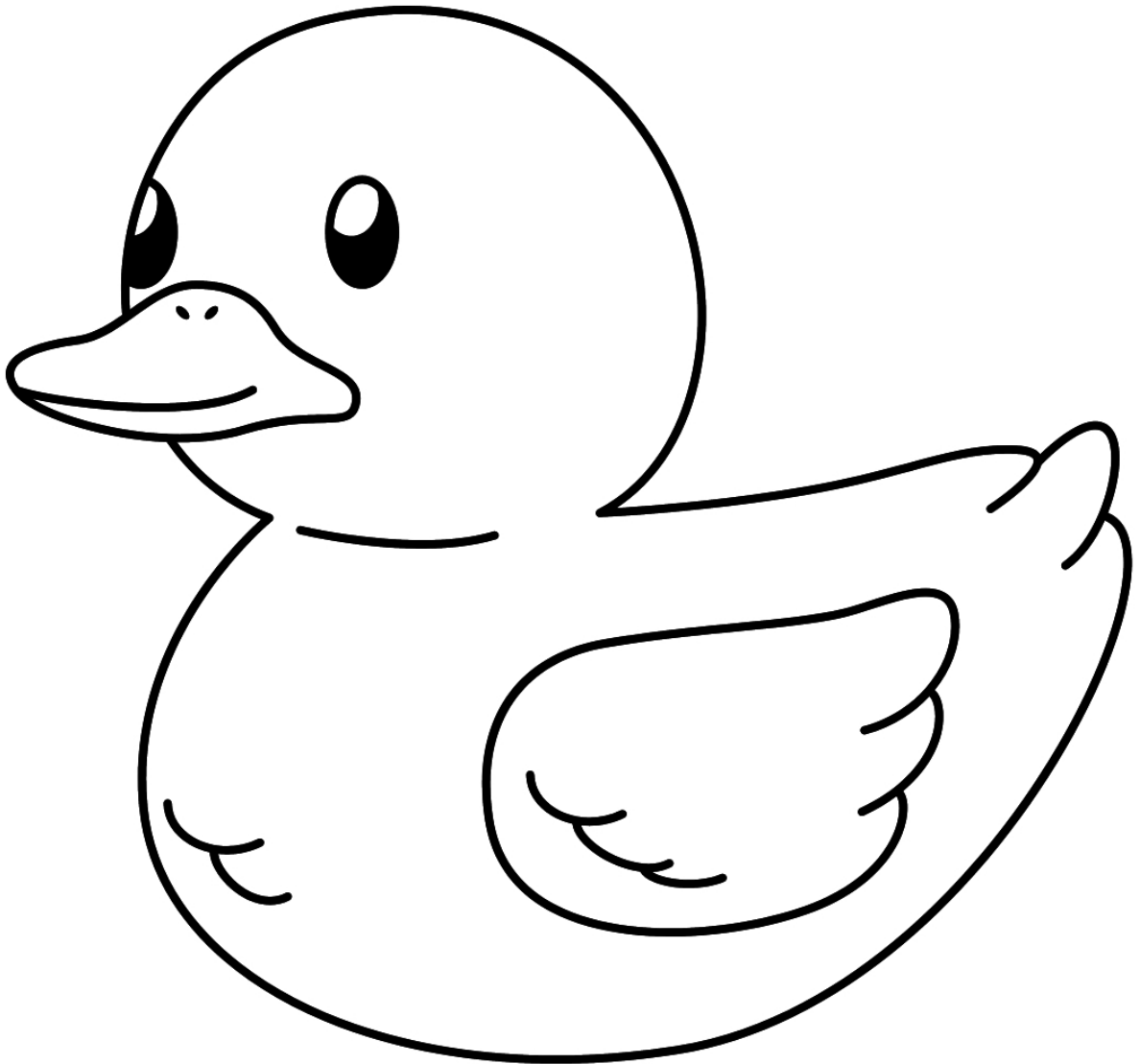

DUCK

Name: _____

Date: _____

Color the drawing and trace the word

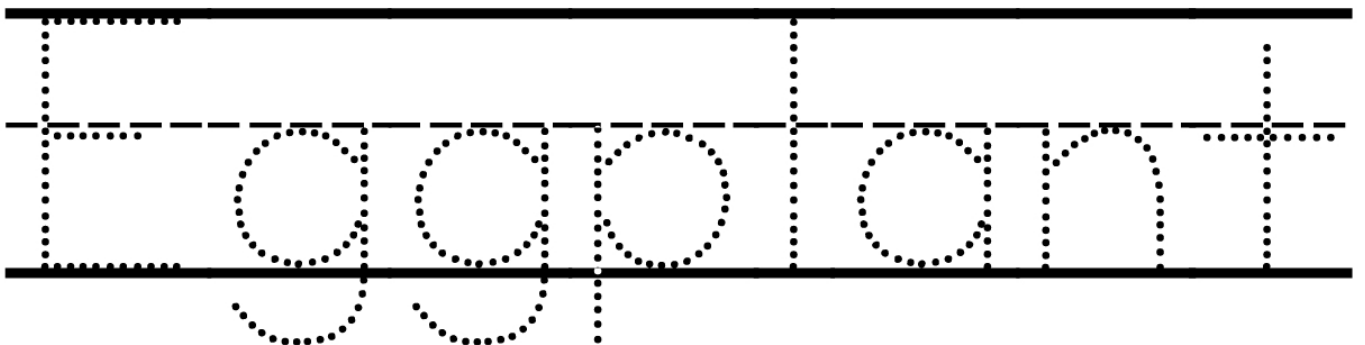
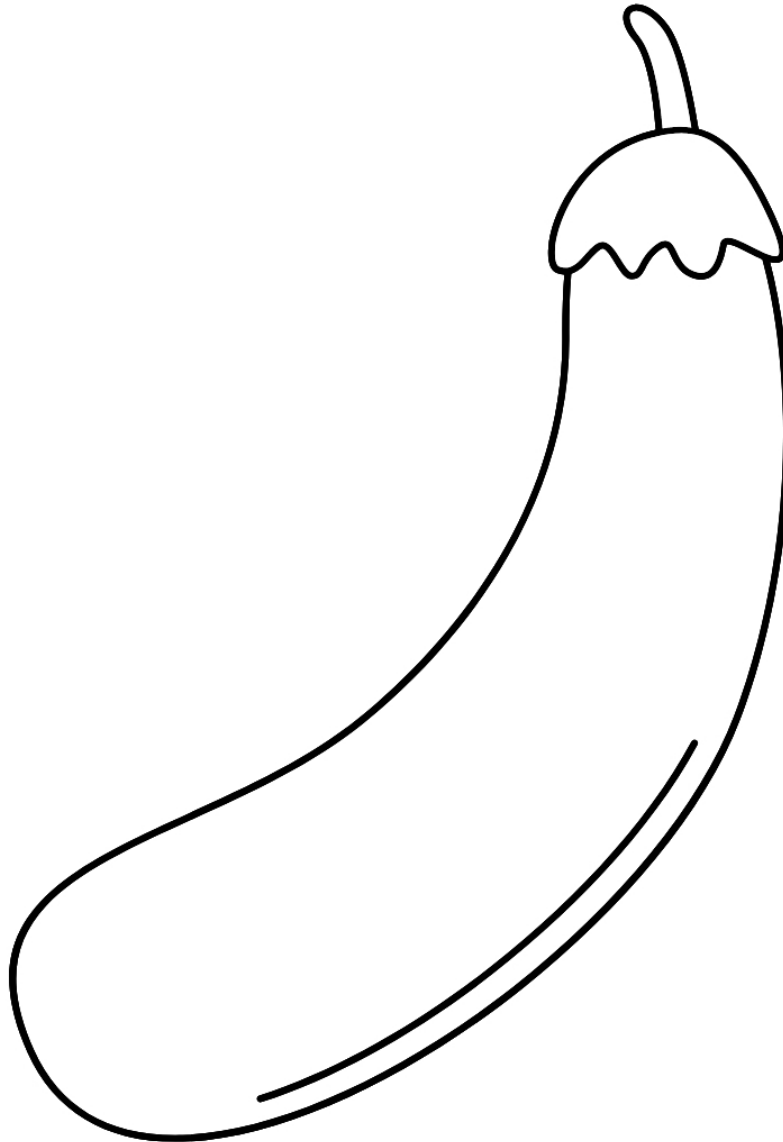

Name: _____

Date: _____

Color the drawing and trace the word

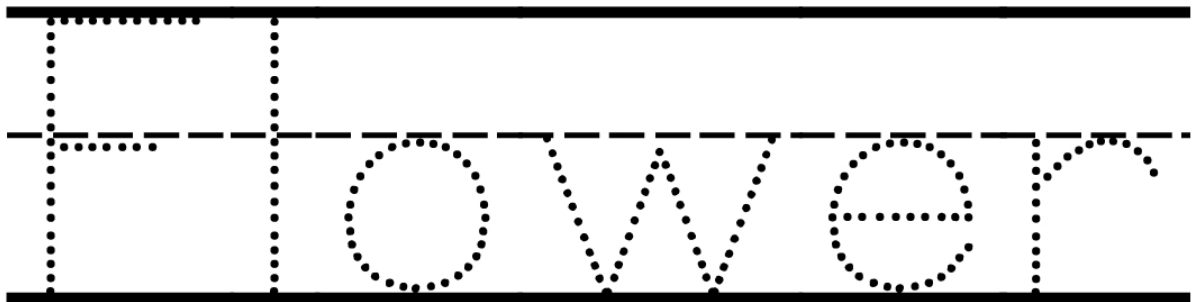
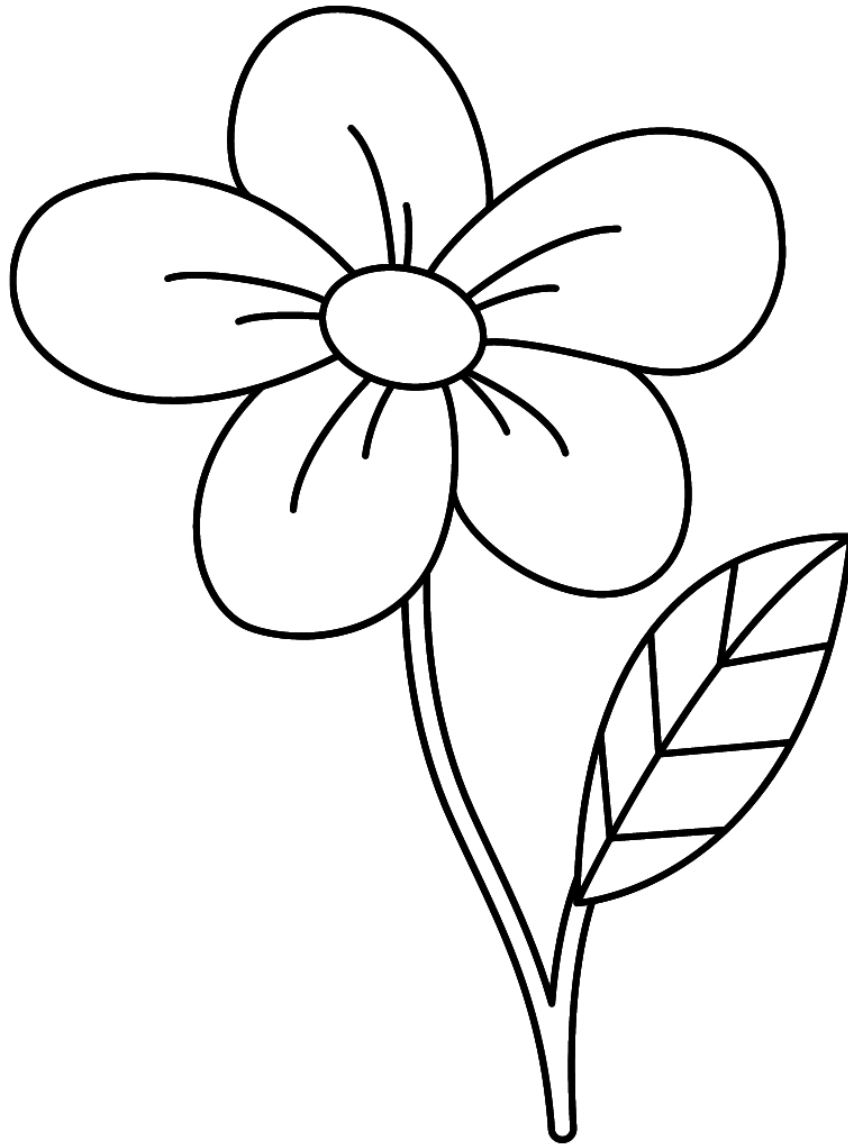

Name: _____

Date: _____

Color the drawing and trace the word

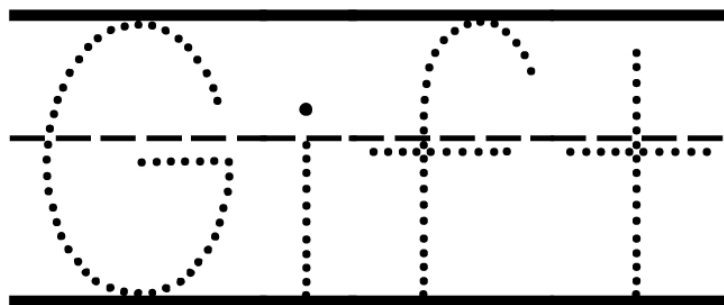
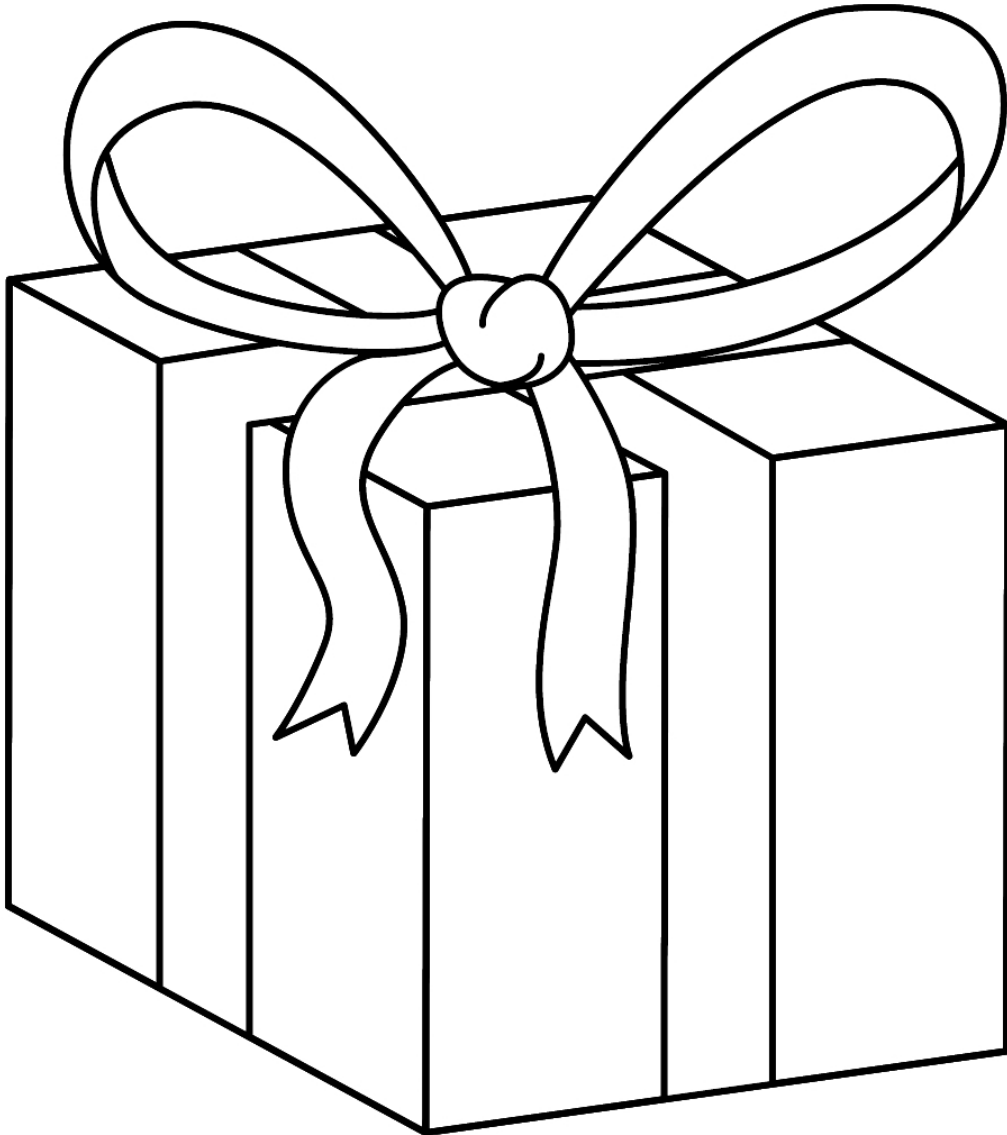

Name: _____

Date: _____

Color the drawing and trace the word

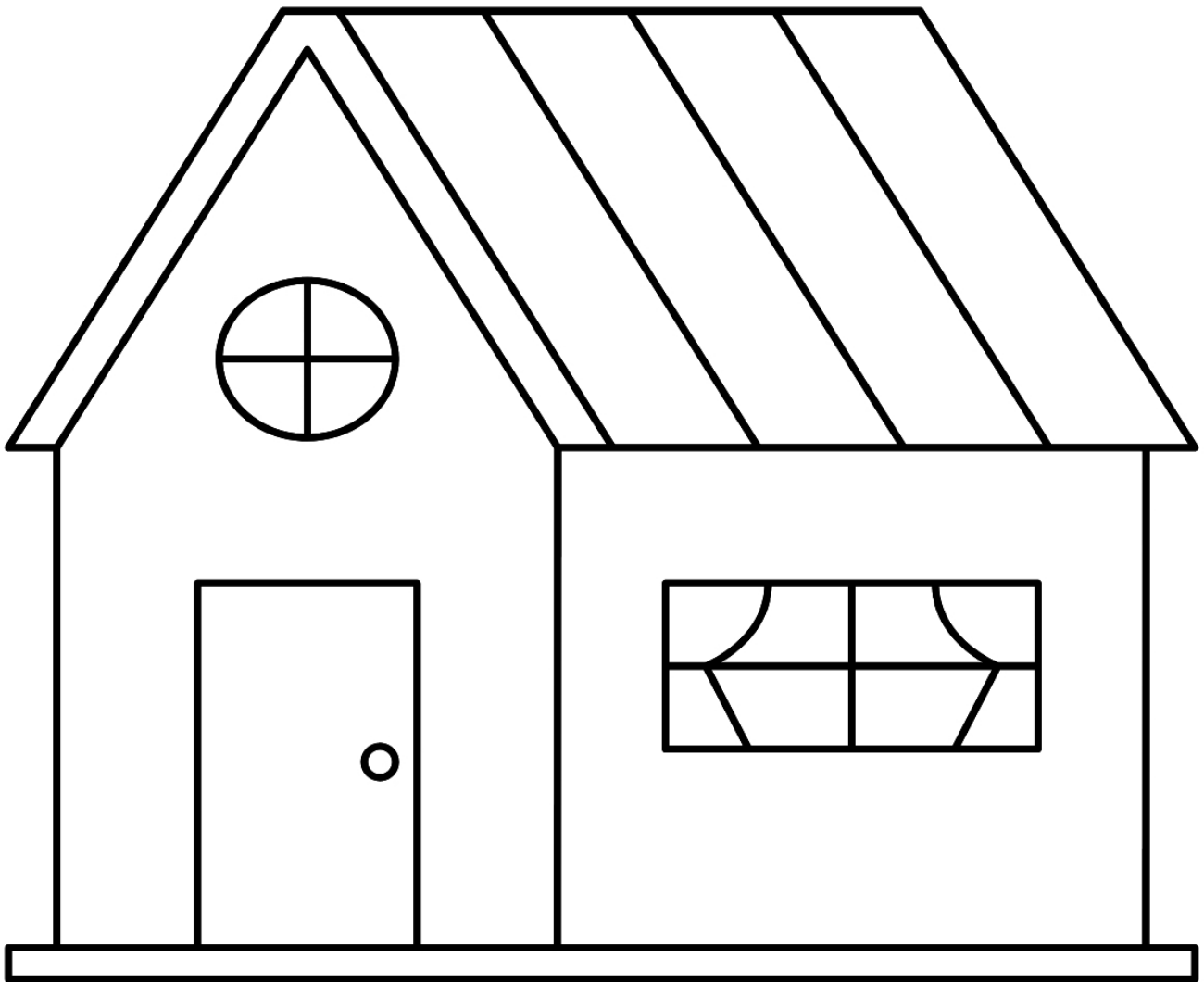

house

Name: _____

Date: _____

Color the drawing and trace the word

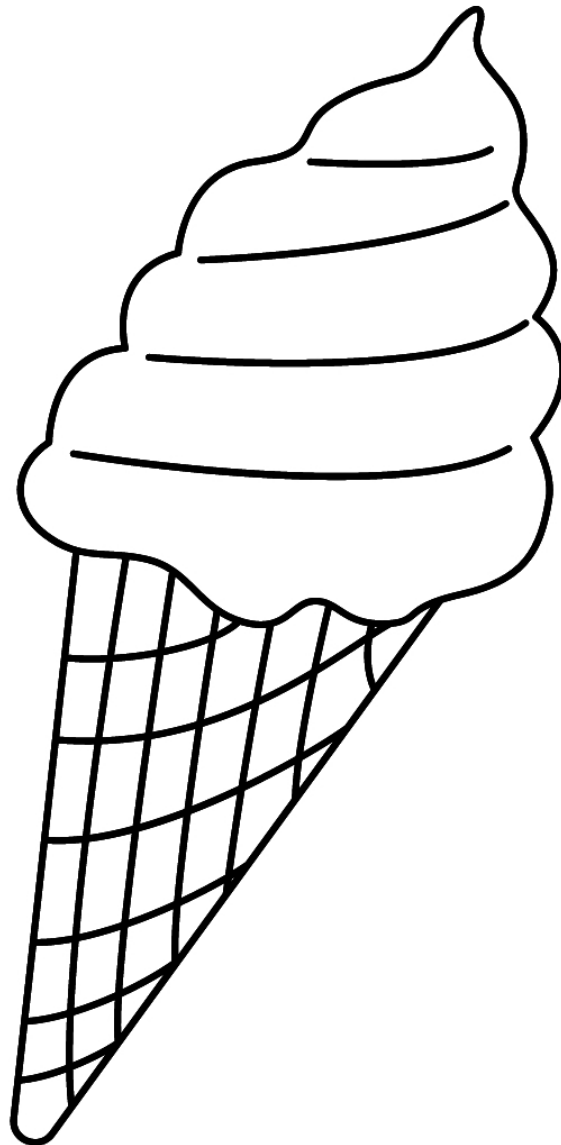

Ice Cream

Name: _____

Date: _____

Color the drawing and trace the word

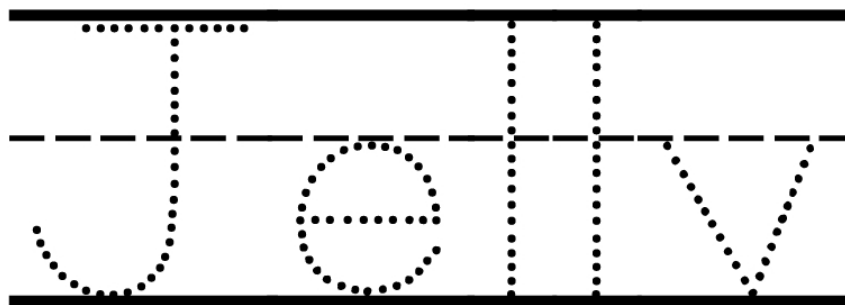
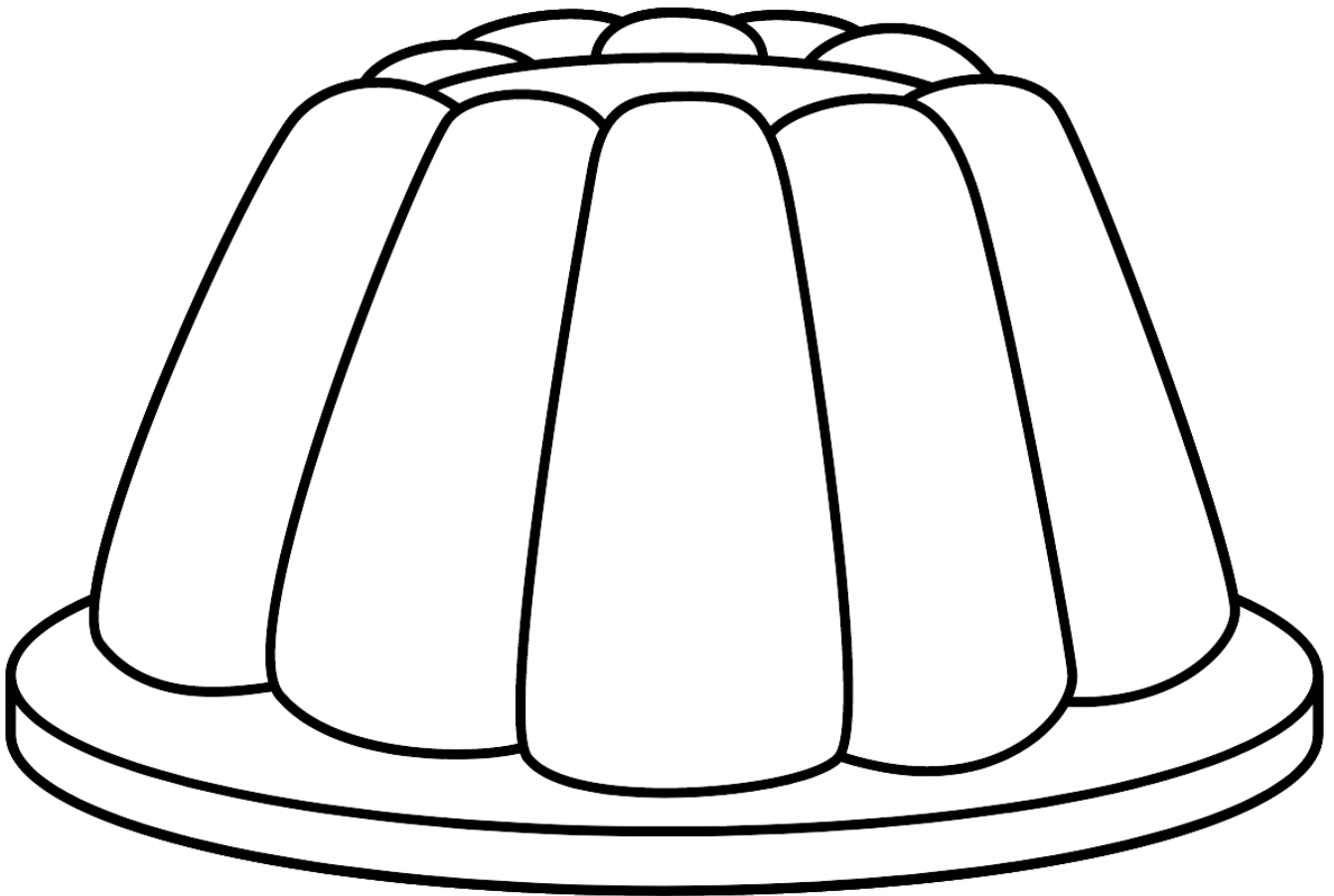

Name: _____

Date: _____

Color the drawing and trace the word

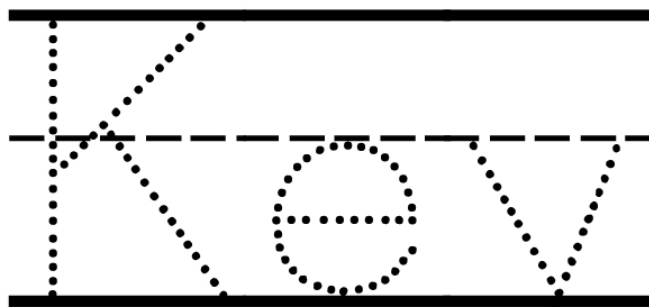
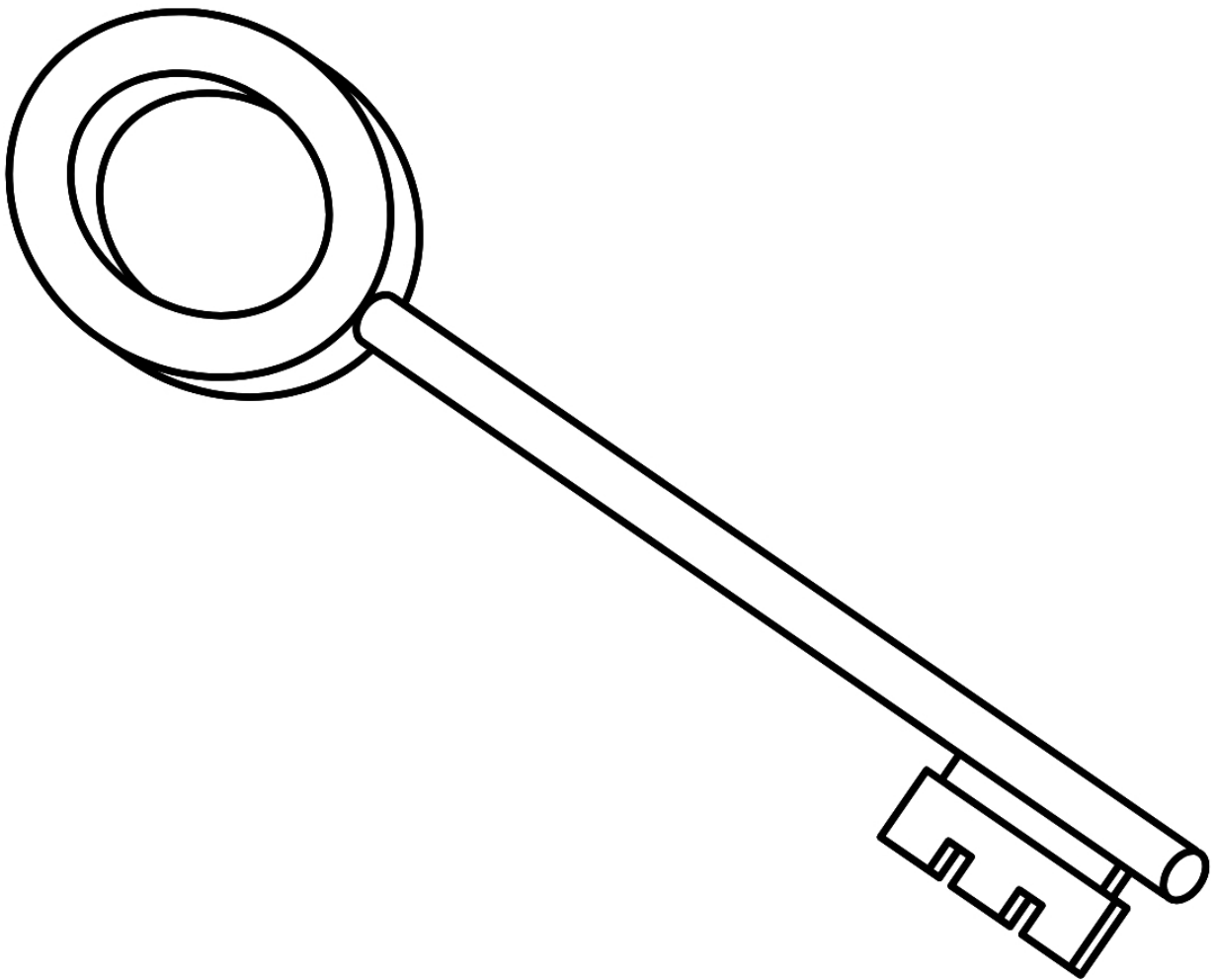

Name: _____

Date: _____

Color the drawing and trace the word

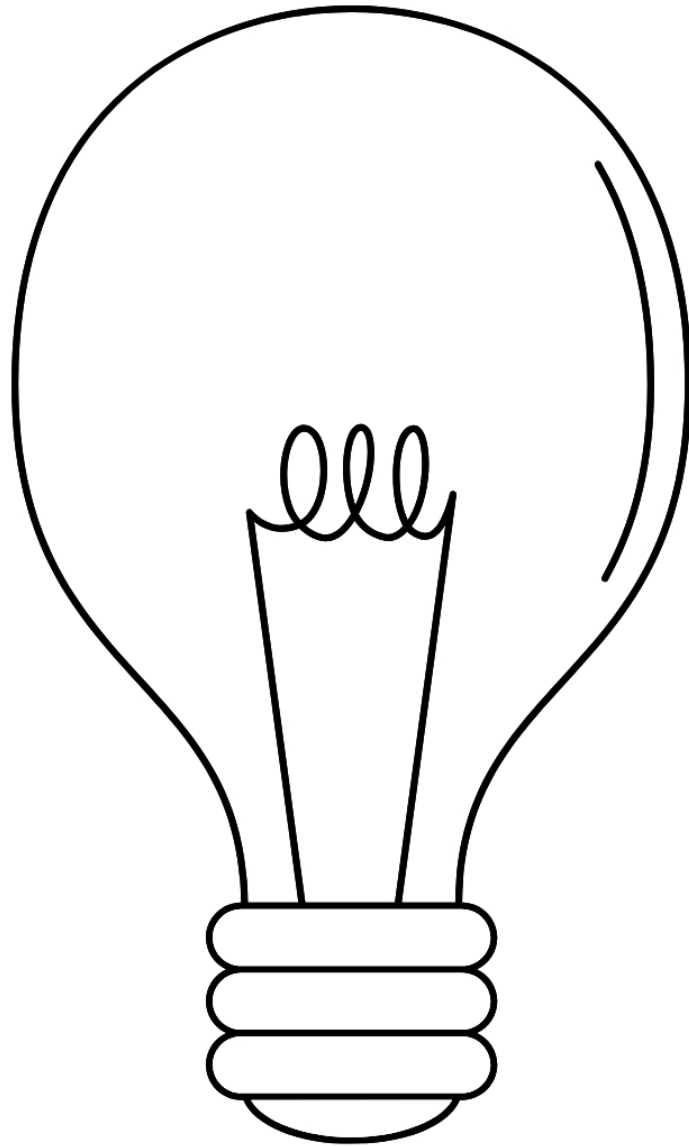

Light Bulb

Name: _____

Date: _____

Color the drawing and trace the word

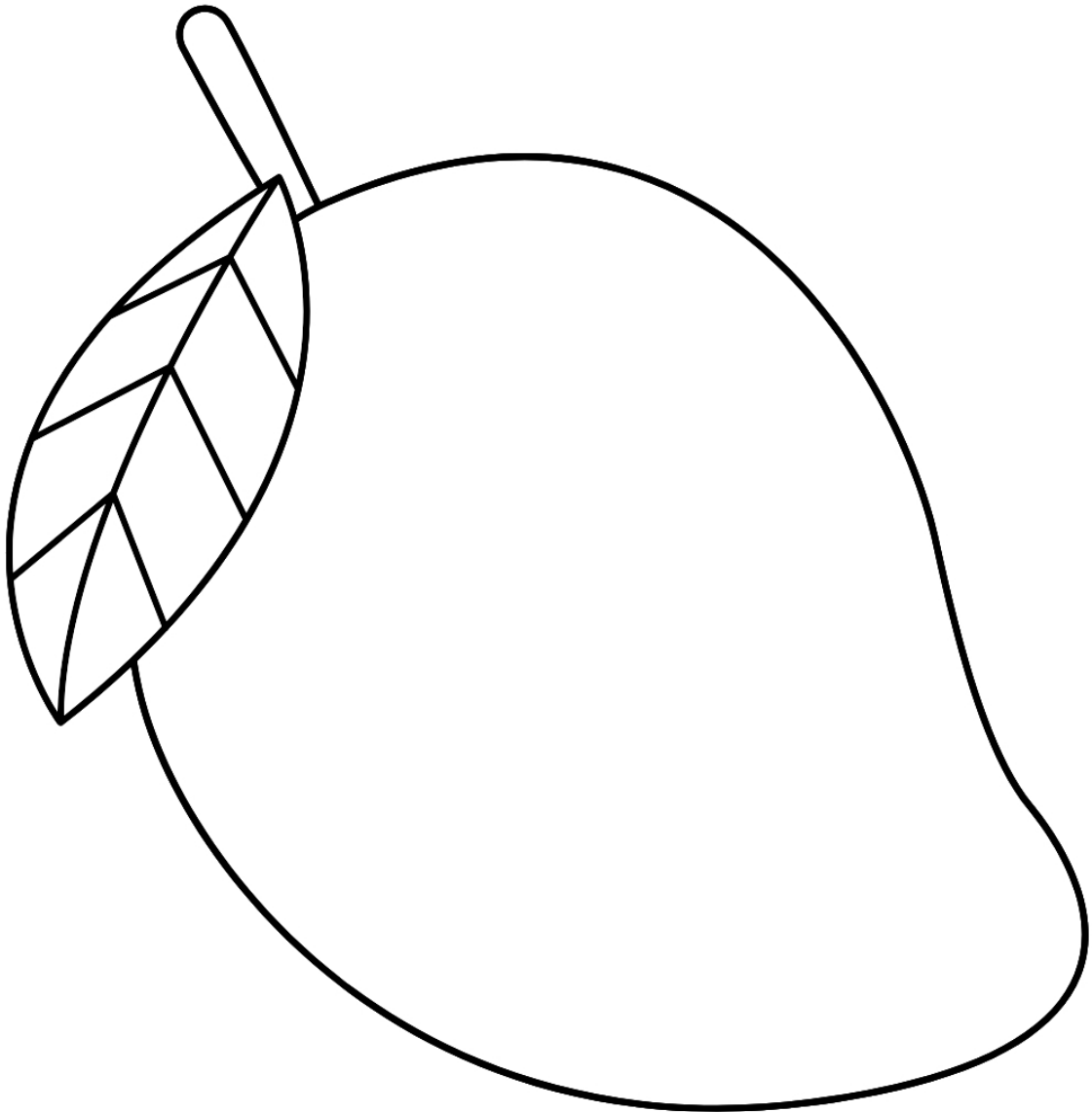

Mango

Name: _____

Date: _____

Color the drawing and trace the word

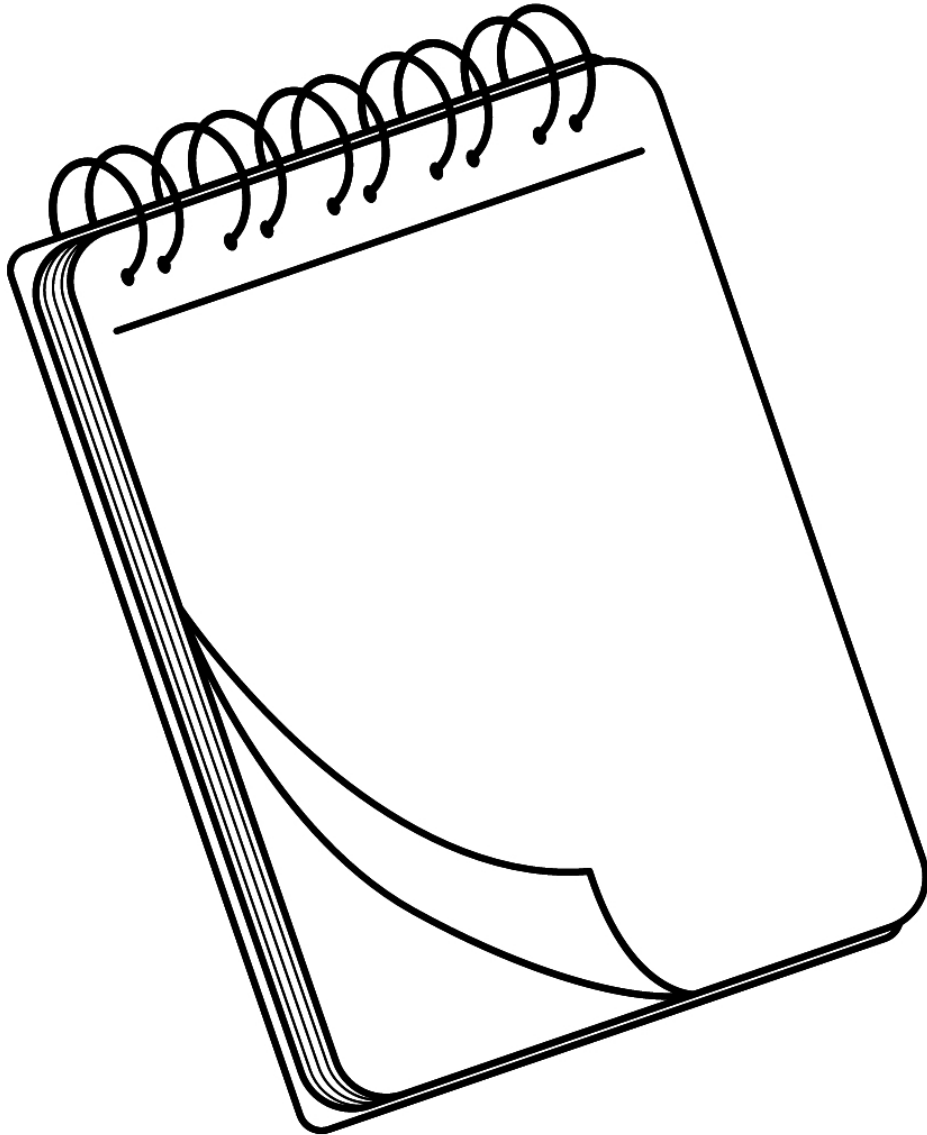

Notepad

Name: _____

Date: _____

Color the drawing and trace the word

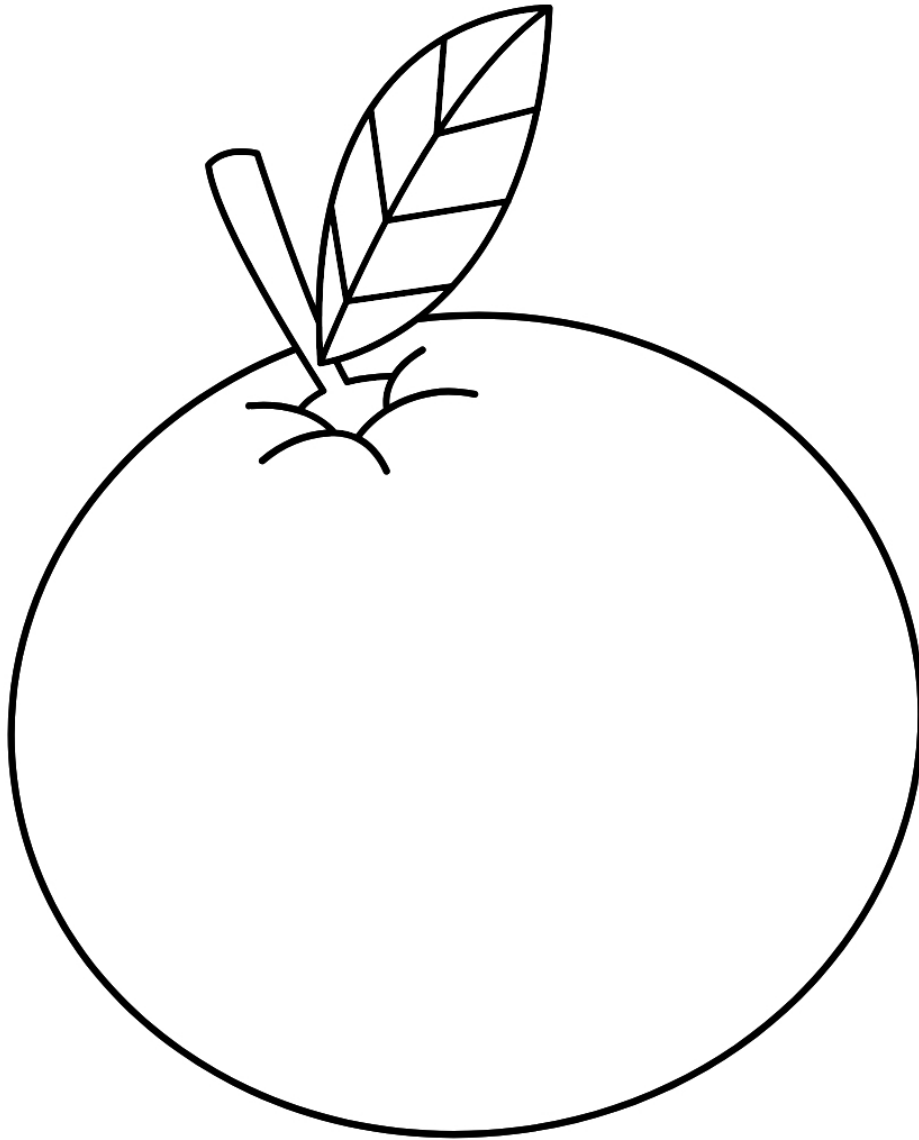

Name: _____

Date: _____

Color the drawing and trace the word

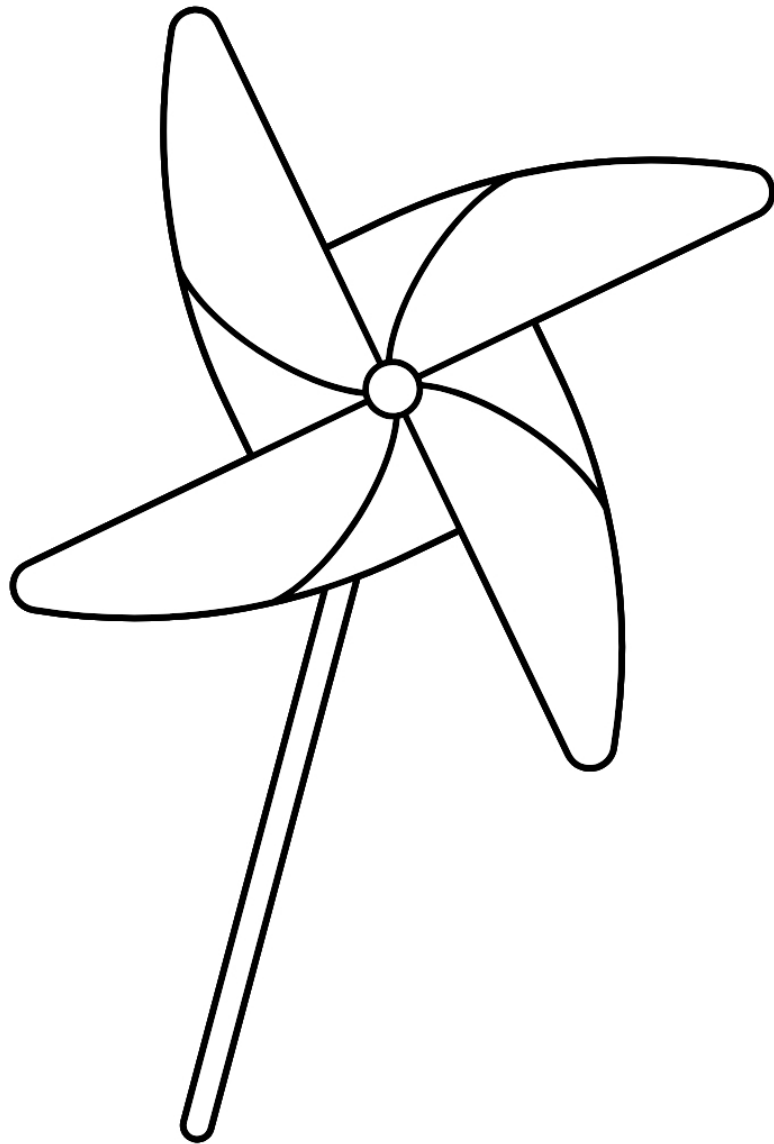

P i n w h e e l

Name: _____

Date: _____

Color the drawing and trace the word

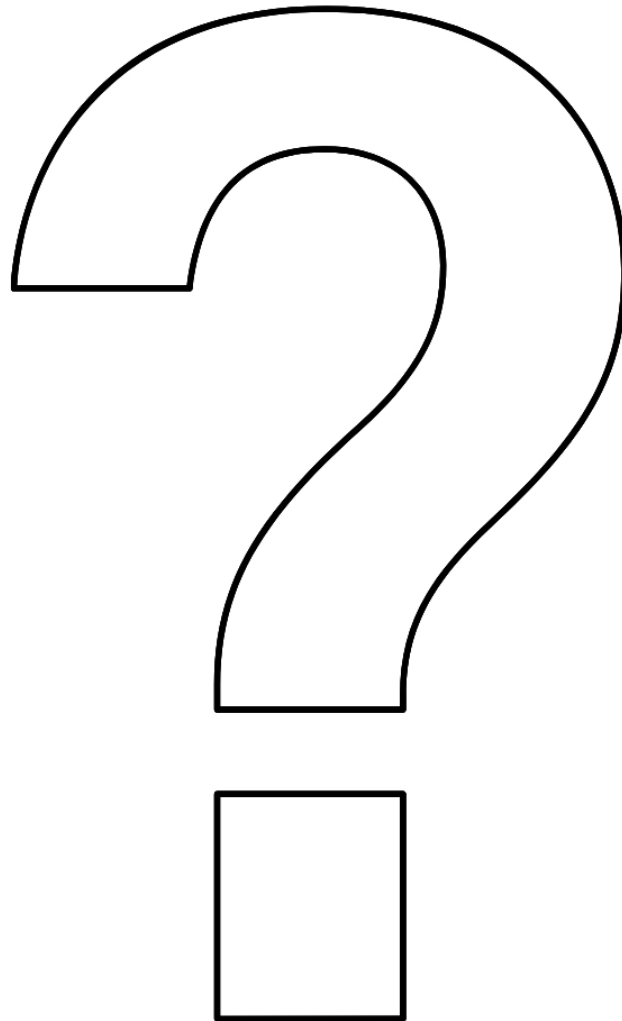

Question

Mark

Name: _____

Date: _____

Color the drawing and trace the word

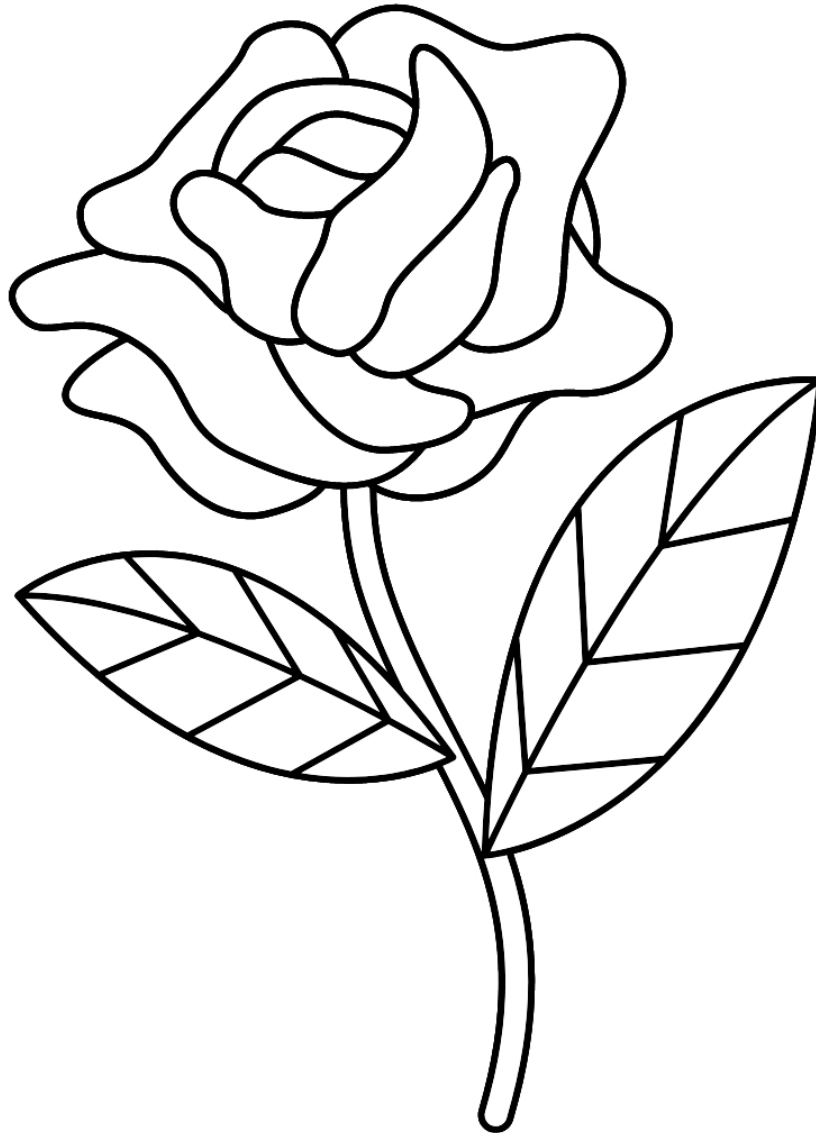

R
ROSE

Name: _____

Date: _____

Color the drawing and trace the word

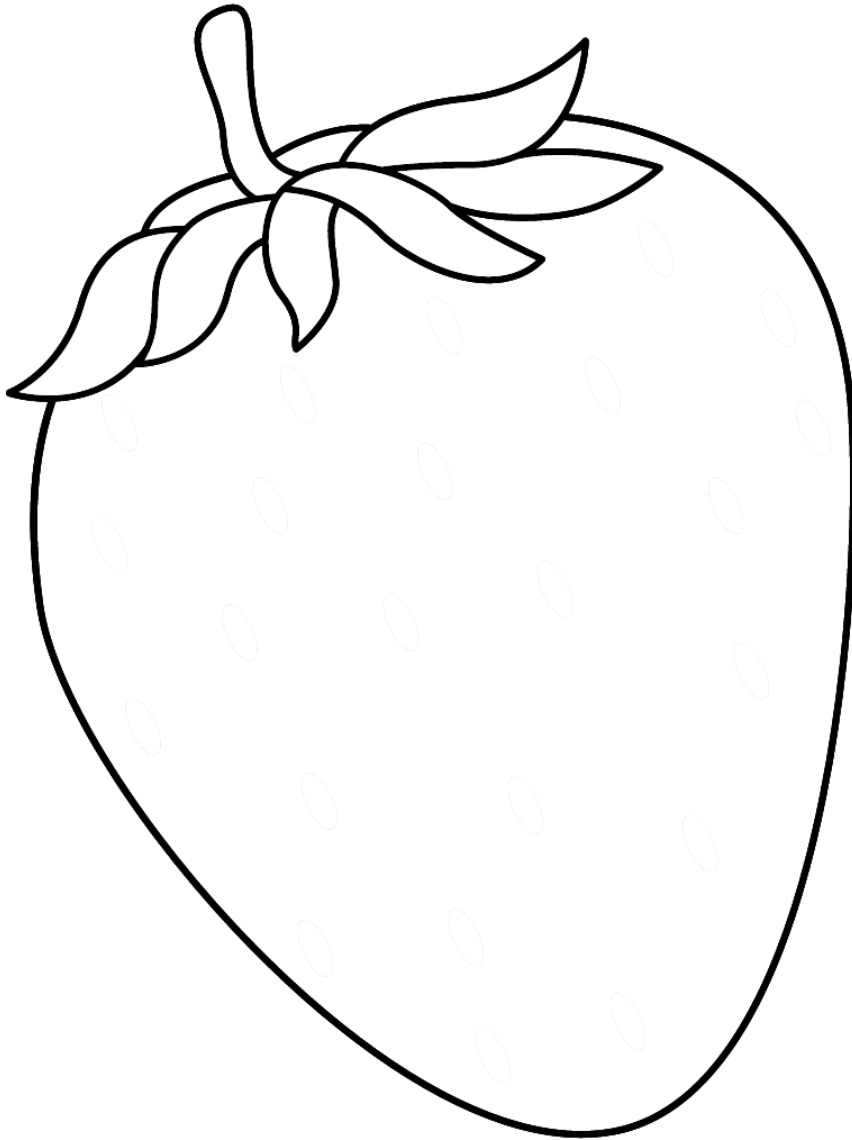

Strawberry

Name: _____

Date: _____

Color the drawing and trace the word

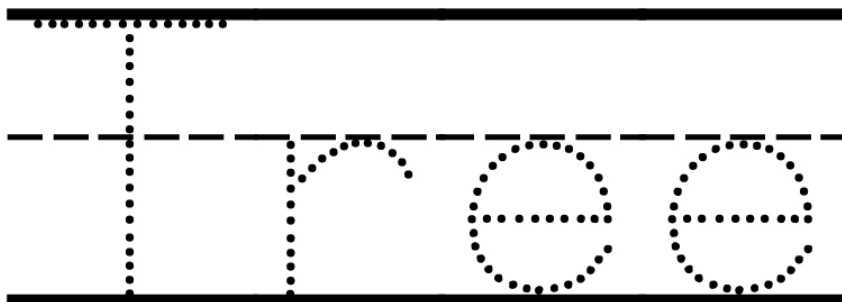
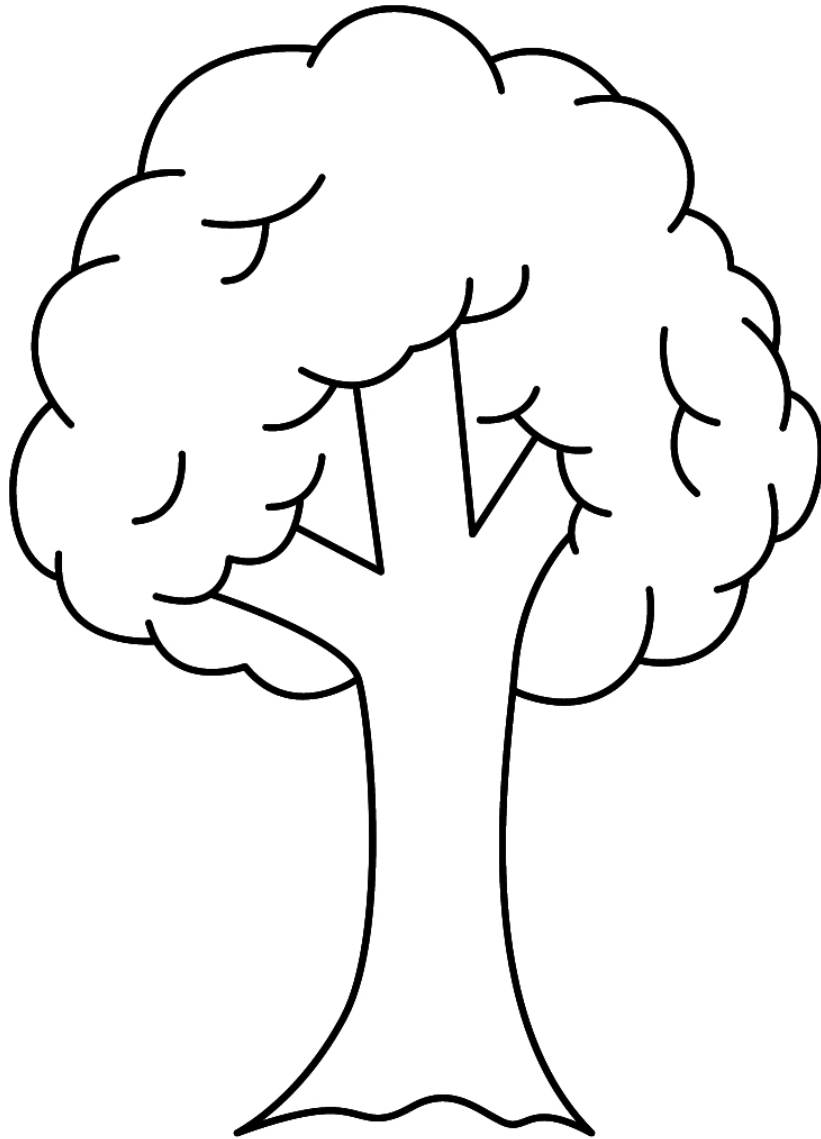

Name: _____

Date: _____

Color the drawing and trace the word



U m b r e l l a

Name: _____

Date: _____

Color the drawing and trace the word

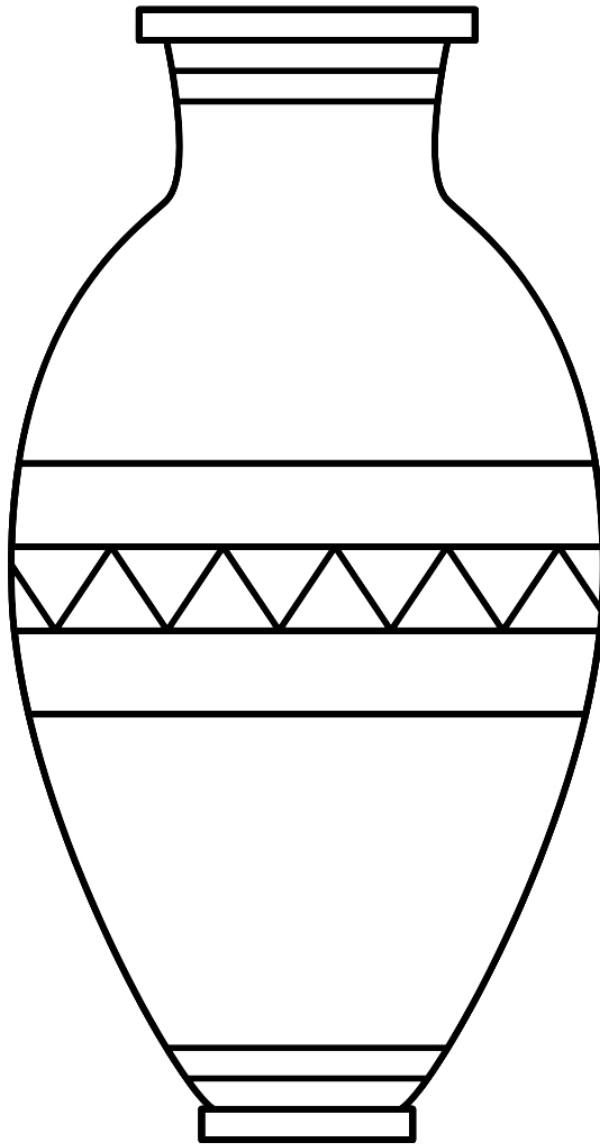

Name: _____

Date: _____

Color the drawing and trace the word

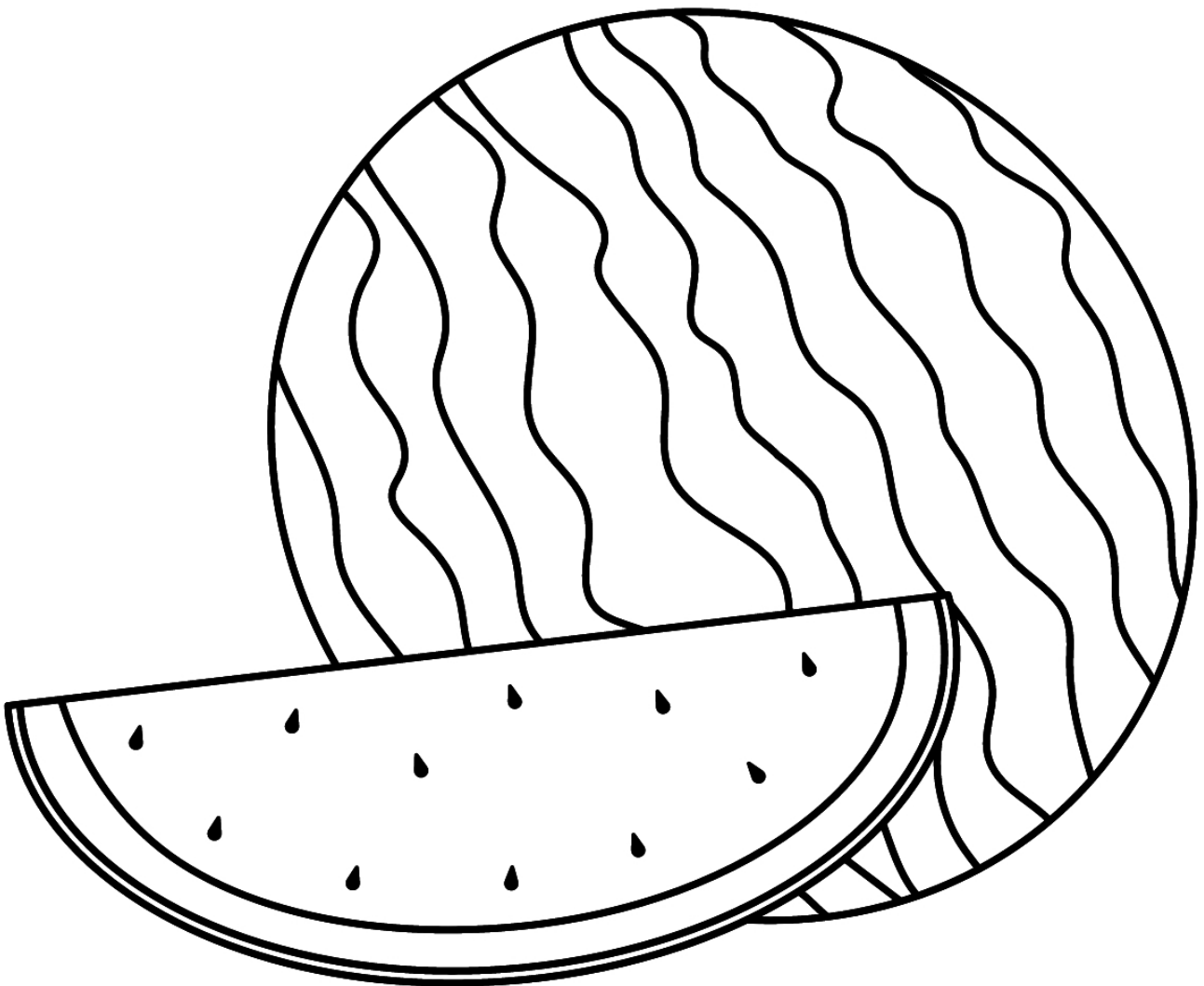

Watermelon

Name: _____

Date: _____

Color the drawing and trace the word

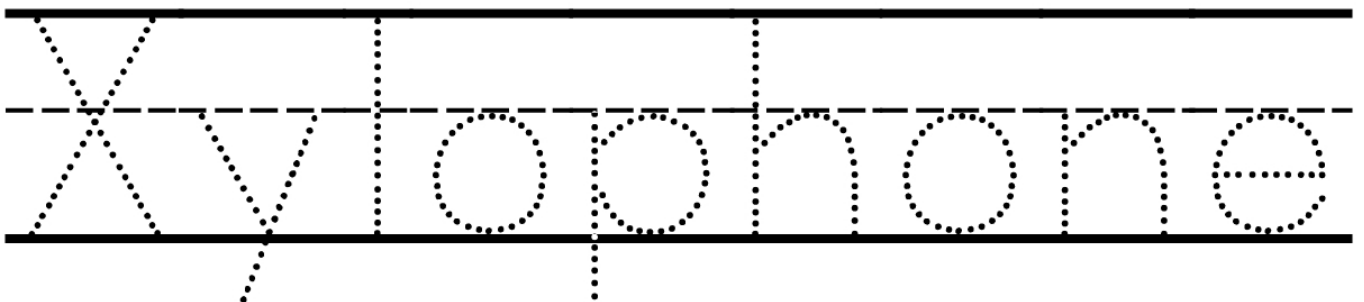
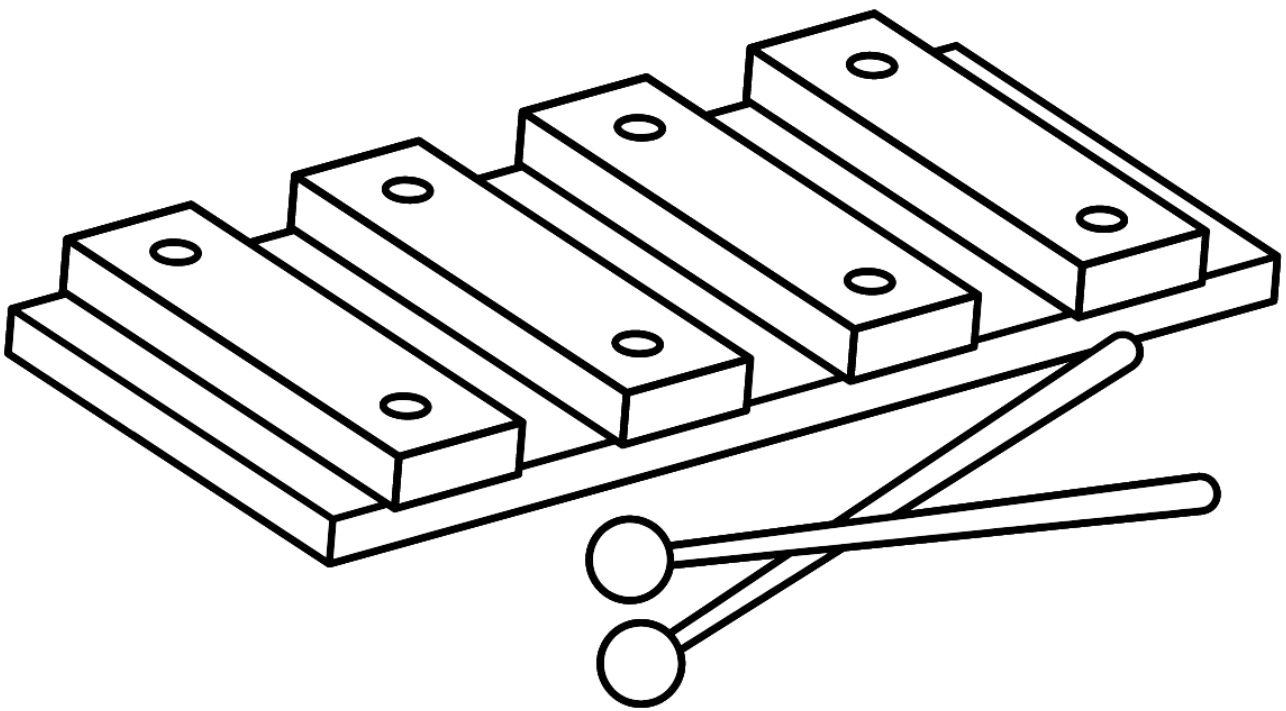

Name: _____

Date: _____

Color the drawing and trace the word

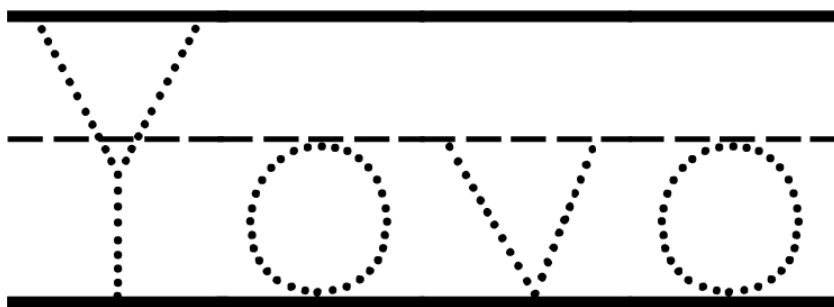
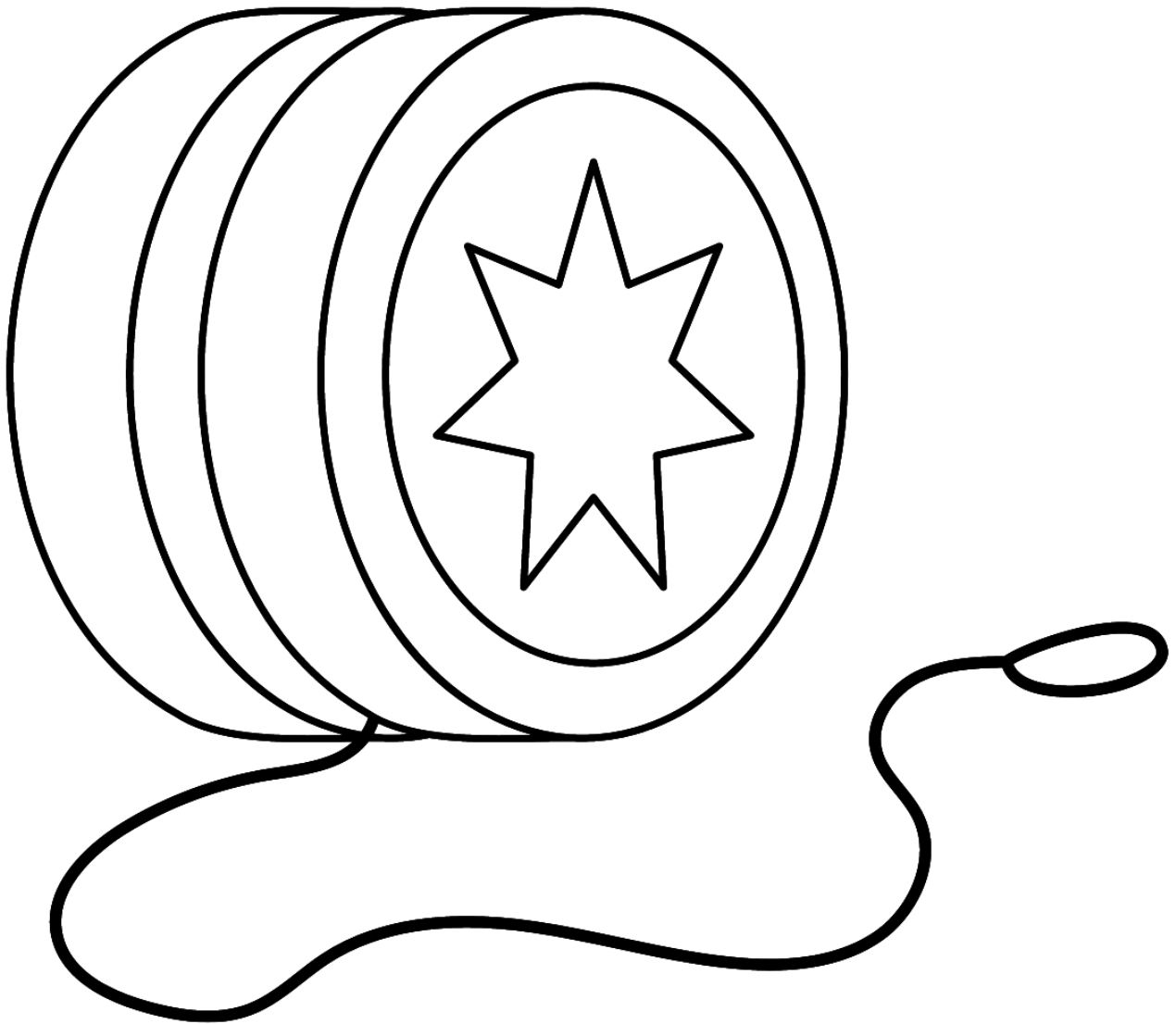

Name: _____

Date: _____

Color the drawing and trace the word

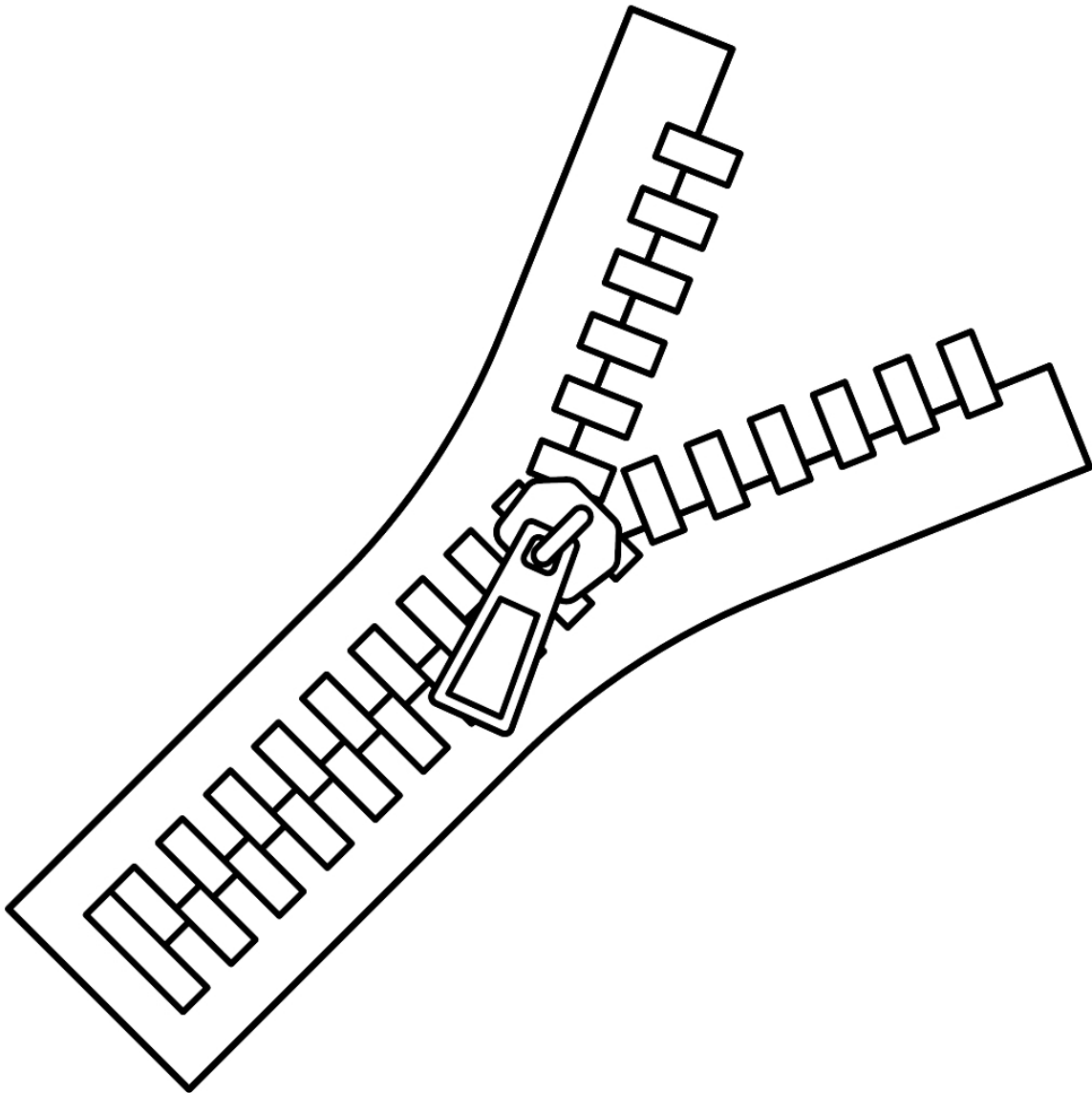



zipper

MATCH THE SOUND

Name: _____

Say each letter sound. Trace the letters.

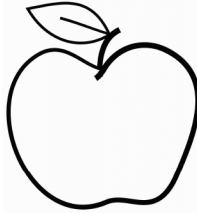
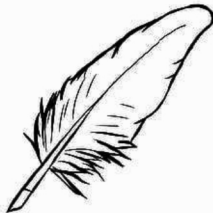
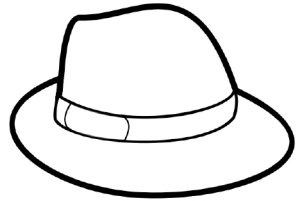
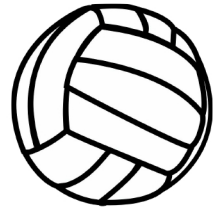
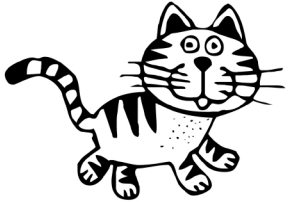
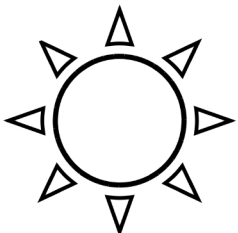
Circle the picture that matches the beginning sound.

a	a	a		
b	b	b		
c	c	c		
d	d	d		
e	e	e	