



dog

www.warq.net



Dog

D D D

D D D

D D D

D D D

D D D



D D D D

D D D D

D D D D D D

D D D D D D

D D D D D D



Handwriting practice lines consisting of two sets of three horizontal lines: a solid top line, a dashed middle line, and a solid bottom line.

Handwriting practice lines consisting of four sets of three horizontal lines: a solid top line, a dashed middle line, and a solid bottom line.

LETTER OF THE WEEK

ACTIVITIES



Dd

Name _____ Class _____

Name _____

Date _____

Trace the letter Dd.

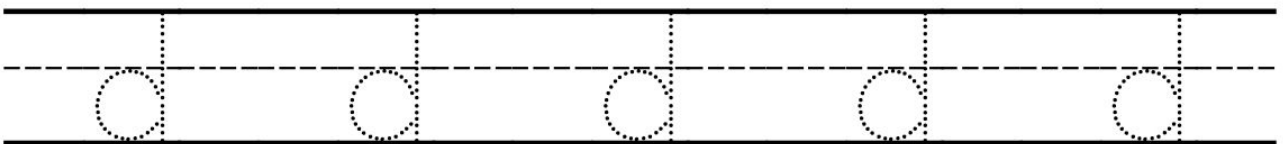
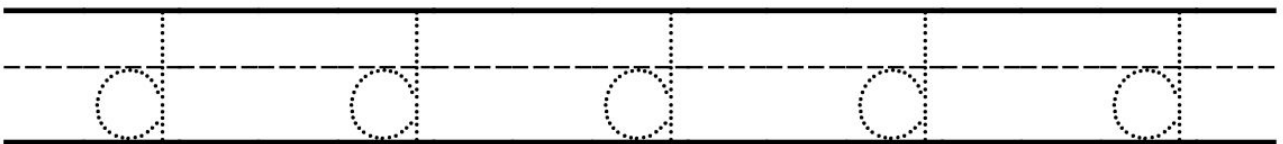
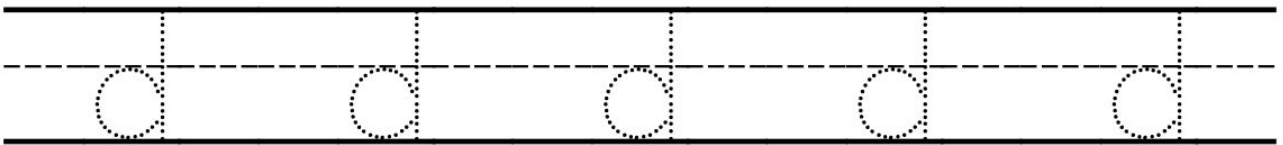
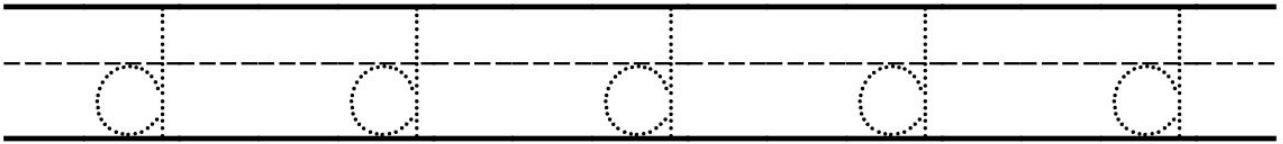
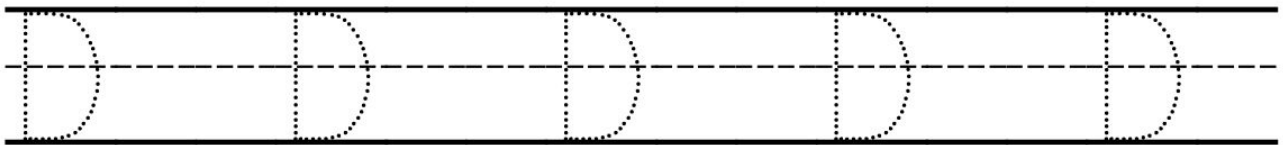
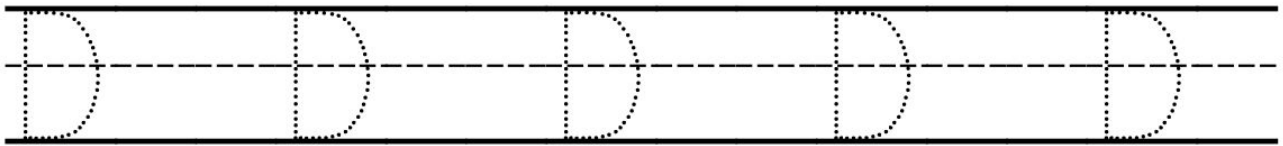
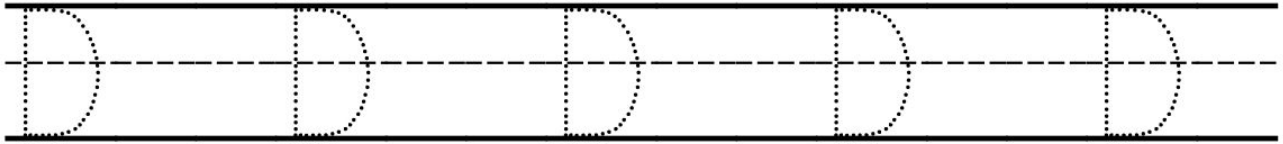
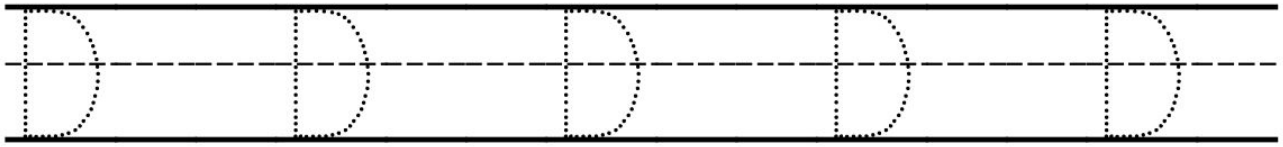

Name _____ Date _____

Write the letter Dd.

D D D D D

Handwriting practice lines for uppercase letter D. Each set consists of a solid top line, a dashed middle line, and a solid bottom line. There are two such sets of lines provided for practice.

d d d d d

Handwriting practice lines for lowercase letter d. Each set consists of a solid top line, a dashed middle line, and a solid bottom line. There are two such sets of lines provided for practice.

Name _____

Date _____

Dab the uppercase D.

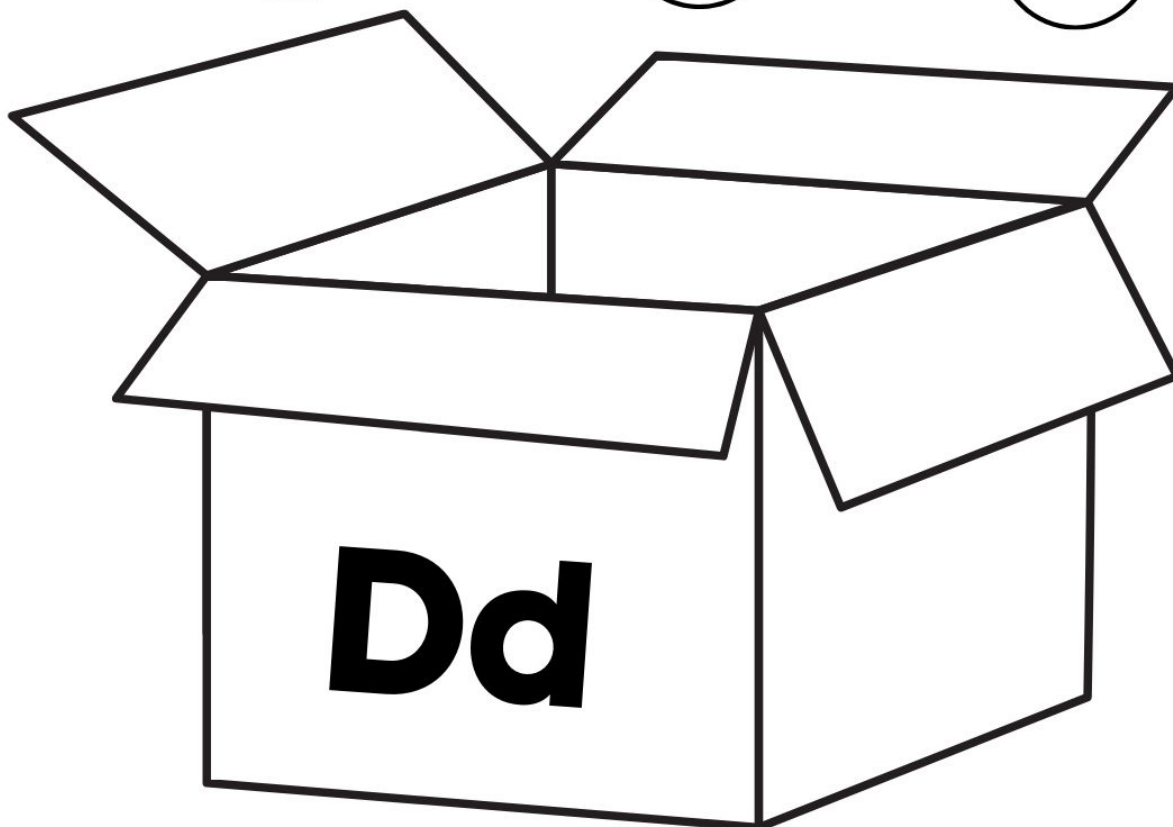
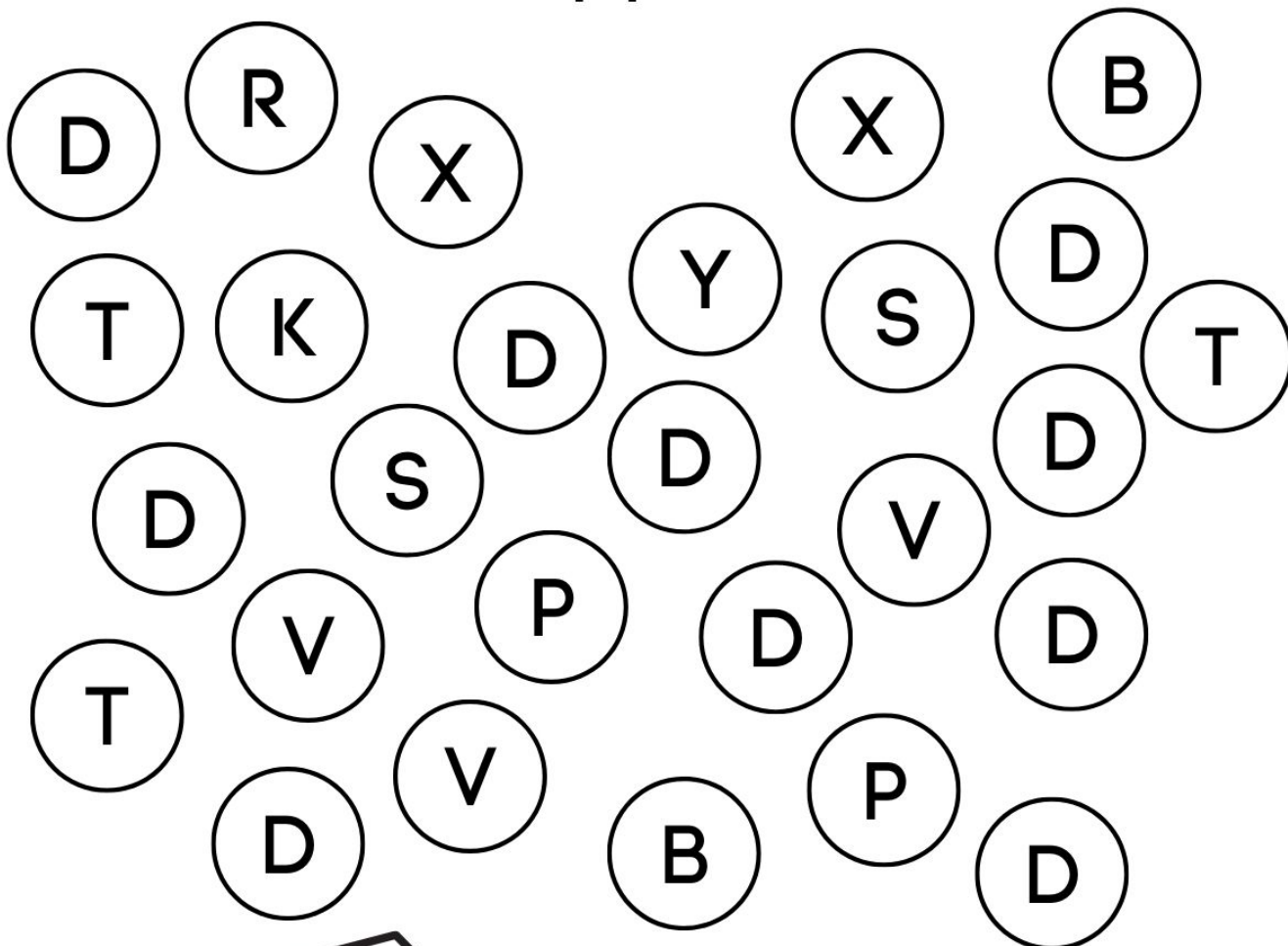

Name _____

Date _____

Dab the lowercase d.

A collection of lowercase letters 'd', 't', 'r', 'g', 'b', 'h', and 's' scattered across the page, each enclosed in a circle. The letters are arranged in a way that allows for a dot-marker activity. The letter 'd' is the target for this activity.

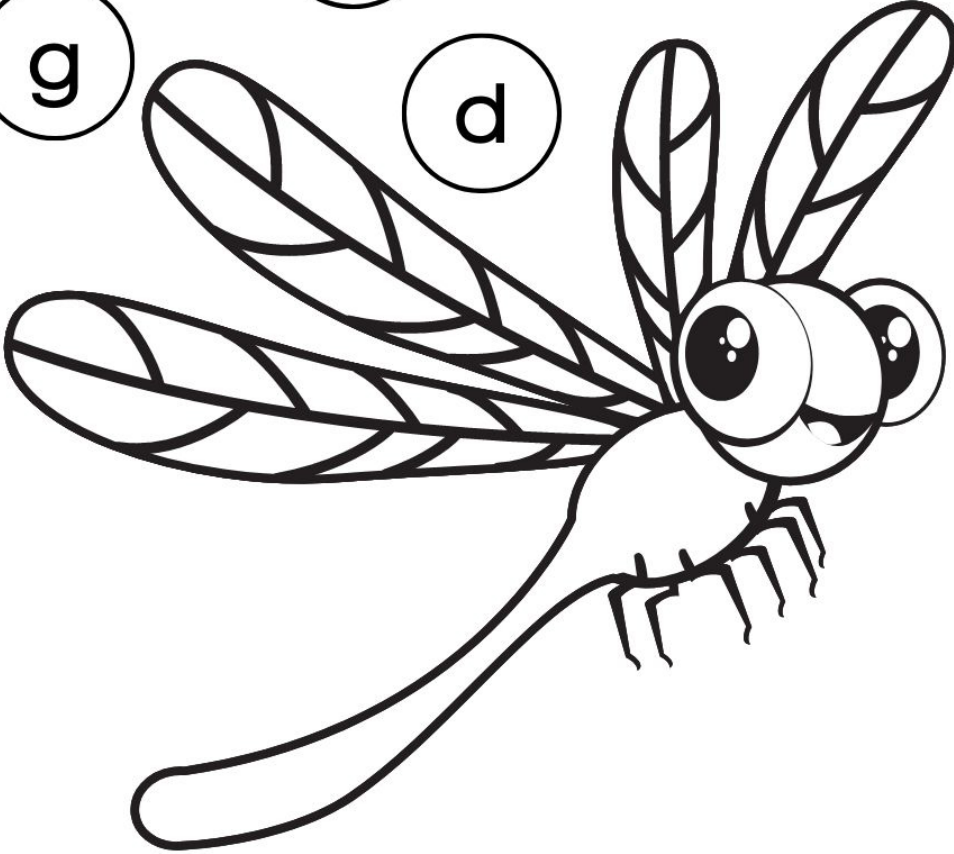

Name _____ Date _____

Draw two pictures that begin with D.

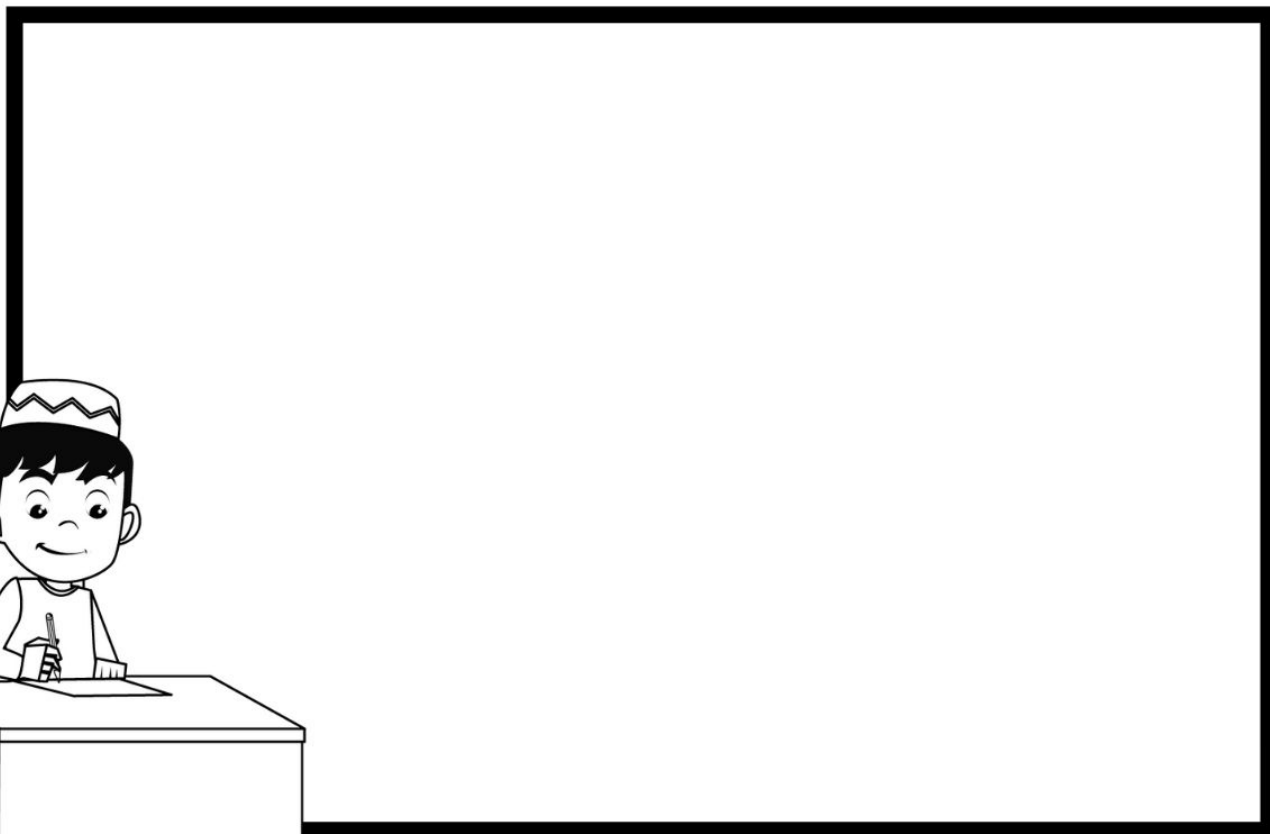

Name _____

Date _____

Color the pictures that begin with D.

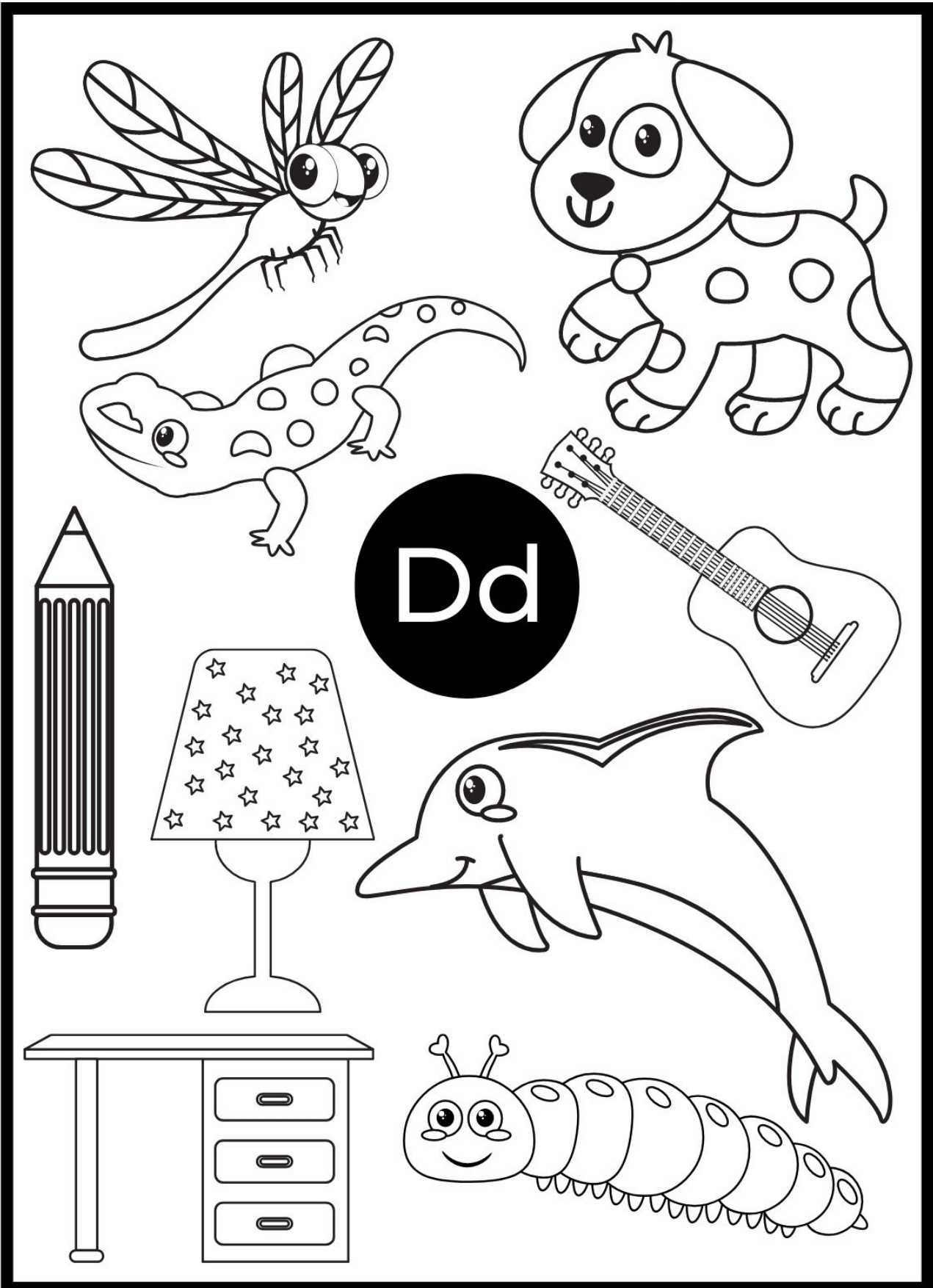

LETTER HUNT!



Find all the letters Dd

d	b	d	a	d
d	c		d	d
c		Dd		b
h				c
d	a	s	v	d
c	b	d	s	d
d	c	d	c	c

Phonics: Dd

Trace using 5 colors on each:

Complete the puzzles:

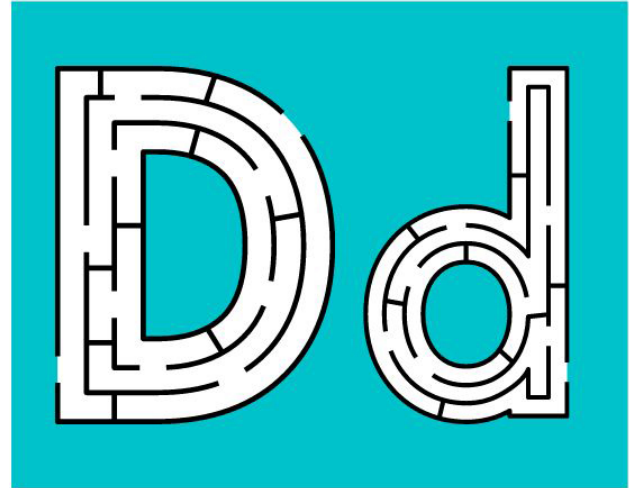
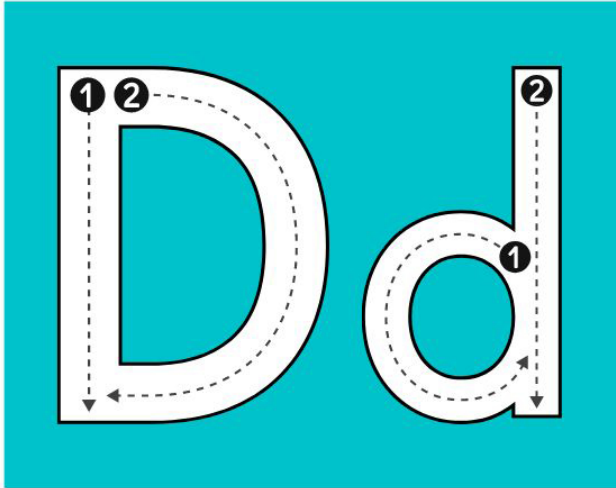

Practice correct letter formation for Dd:

Brainstorm words that use each of these sounds:

/ d /

dot

Read these 'd' words:

dad

dot

dip

dim

den

• The letter D •

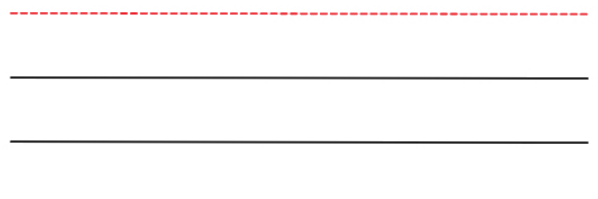
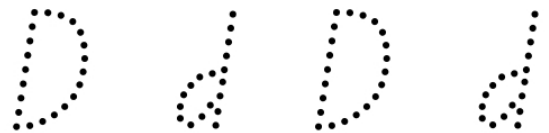
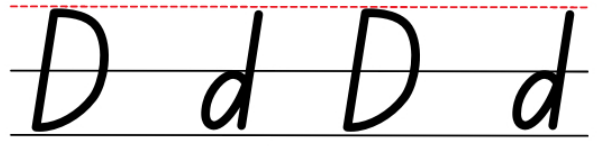
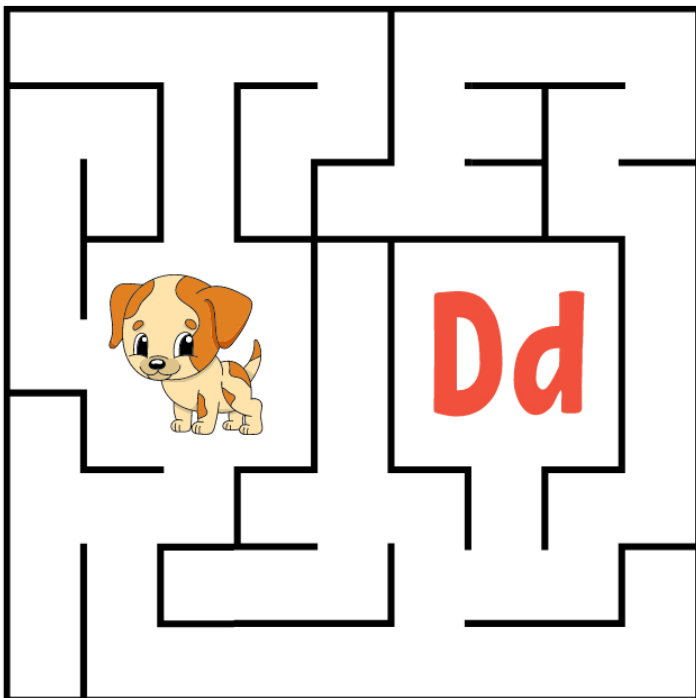
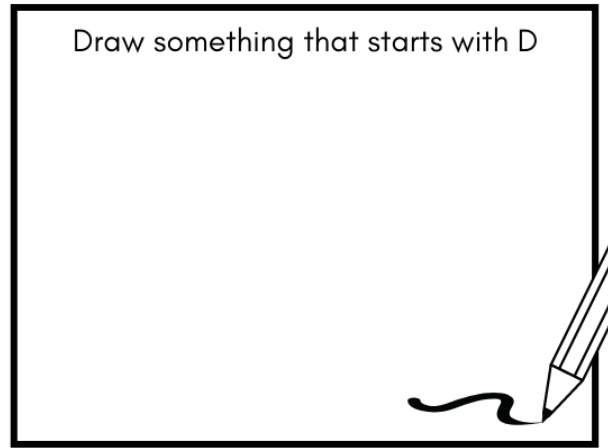
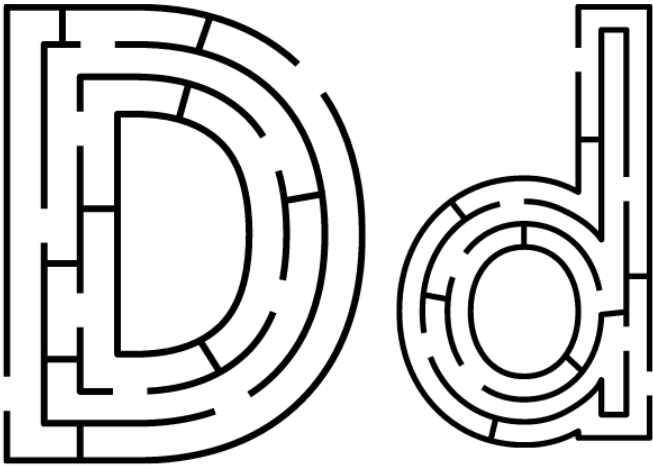
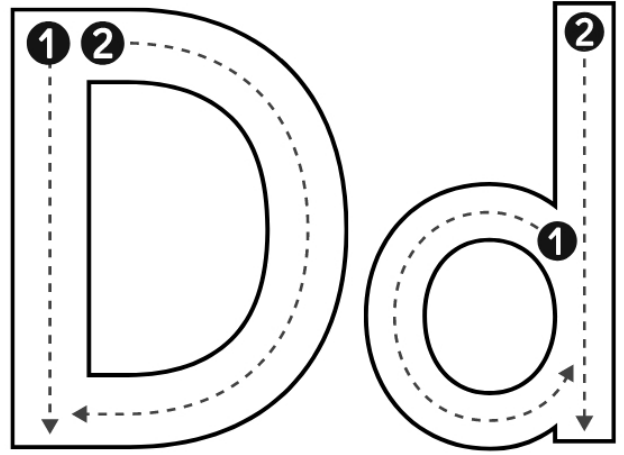
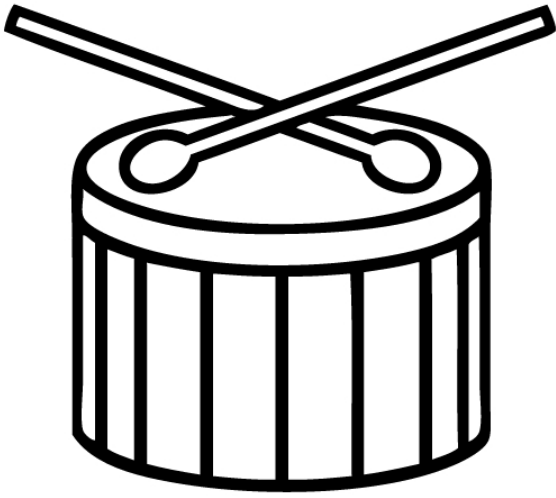

Letter of the Week

Dd

Name _____

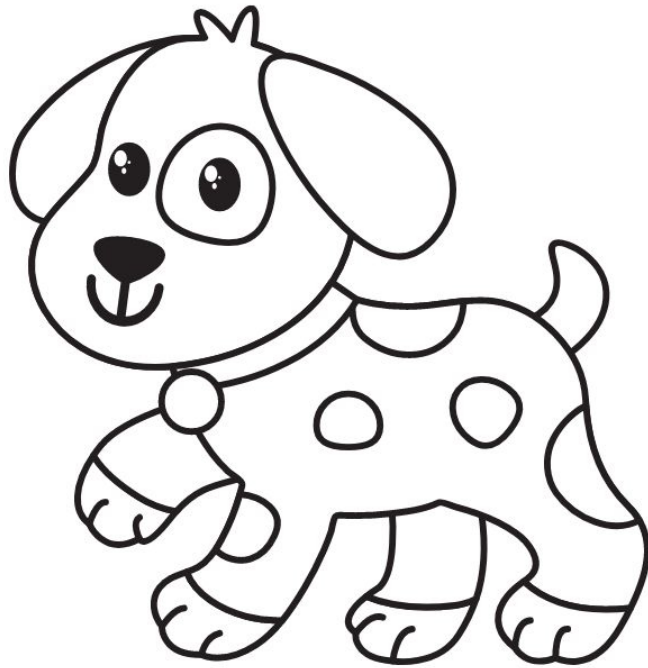

D is for dog.



D is for doll.



D is for deer.

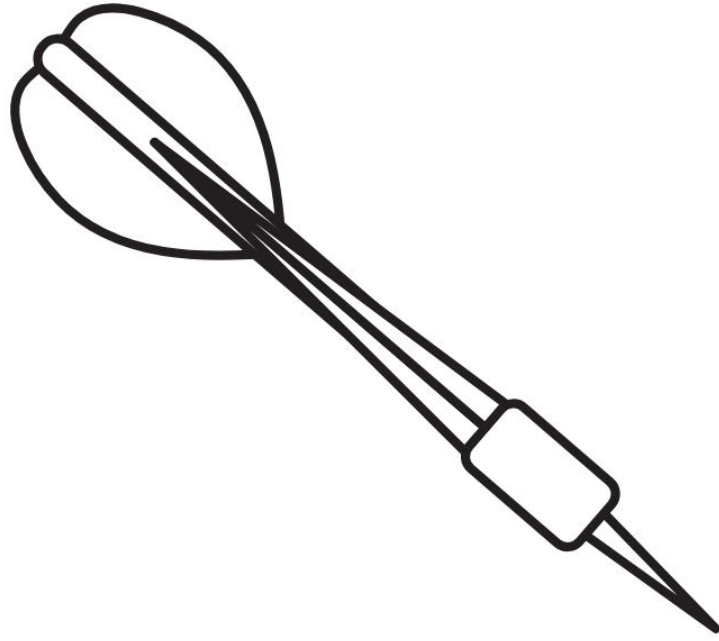

D is for **dart**.

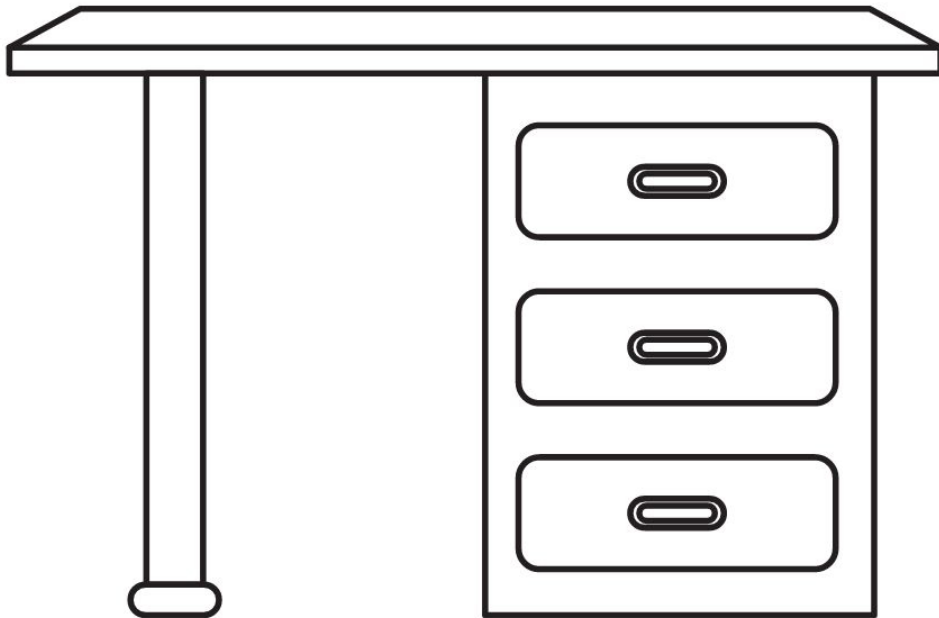

D is for **desk**.

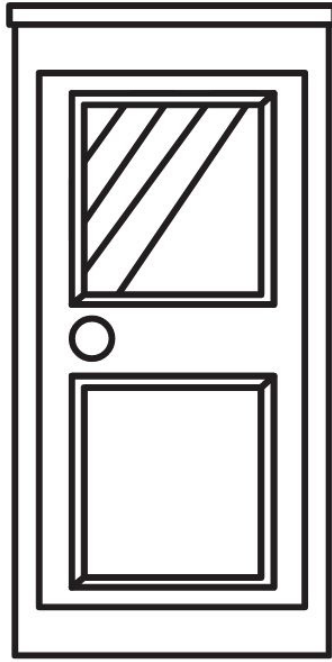

D is for door.

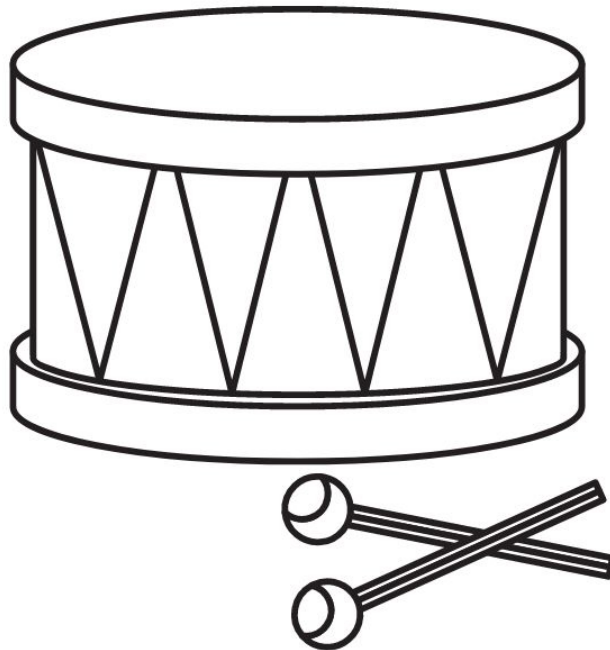

D is for drum.

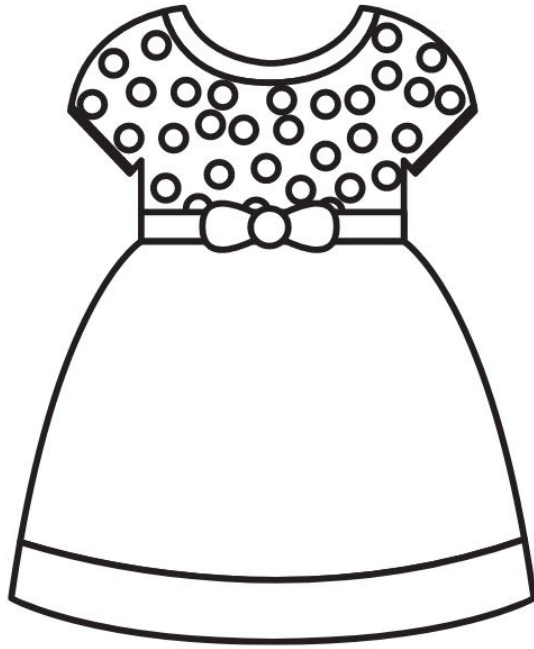

D is for dress.



D is for donut.

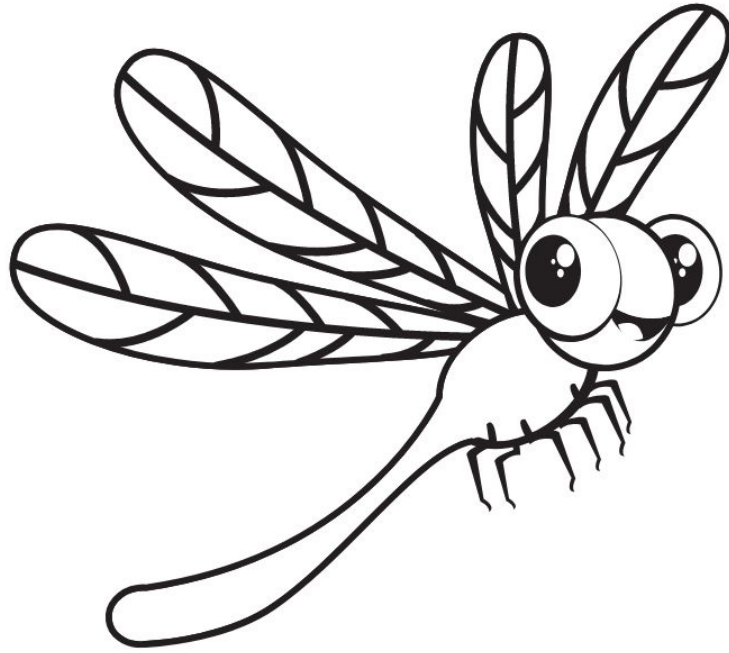

D is for dragonfly.

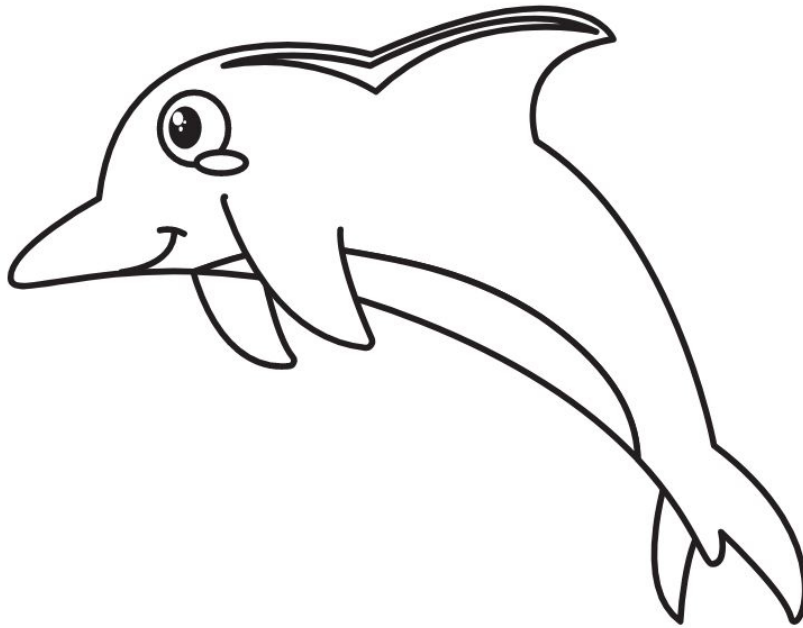

D is for dolphin.